

MAIN CATALOGUE

HARTMANN TRESORE

Burglar-proof safes

Burglar and fire-proof safes

Filing cabinets

Data media safes

Furniture safes

Wall and floor safes

Key safes

Deposit and drop-down safes

Strongroom doors



...security at your service!

HARTMANN



TRESORE AG

About us

HARTMANN TRESORE AG is a modern company that has grown out of a long line of craftsmanship and tradition. More than 200 hundred years ago "Schmiede und Stellmacherei Hartmann" (a blacksmiths and cartwright company) was founded in Westphalia. We are proud that the steel construction company is a still family-run business. Christoph



and Heinrich Hartmann founded HARTMANN TRESORE in 1983. It is an innovative and high-performance company that faces up to the challenges of a long-standing tradition.

Performance through experience

Innovative ideas and expertise: a combination you can trust. Just as many of the 100,000 other satisfied customers worldwide before you have done.

Security with a system

To secure your valuables we not only offer you a safe; we offer you a comprehensive security package. Alongside security solutions for private use, our strengths lie in offering security devices across various sectors.

We know what is needed and are able to turn legal requirements into creating the right kind of solutions.

Our security package for you:

Quality

Our safes are characterised by the high-quality materials that are used in their manufacture and by the precision with which they are made: all safes comply with the high German safety requirements of the VDMA (German Engineering Association) and VdS GmbH (no called the Trust through Safety Association) in line with the European standard. This is very important concerning insurance coverage. High quality is a prerequisite!

Service

There is no such thing as "no can do!" This motto has a tradition within the company. The purchase of any security system requires individual and discreet consultation and customer care. We are very aware of this! We are your competent partner from the first noncommittal consultation right up to the complete planning and execution phase. Our customer care service will be there to support you long after you have purchased with us.

Pricing

It is our goal to achieve the most optimal price-performance ratio for you, which is why we reinforce the idea of price-conscious purchasing while still striving for high quality and rational manufacture of our products. This is security at staid prices!

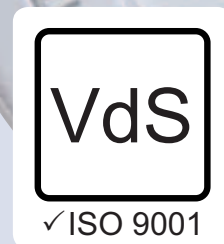

European Security Systems Associations (ESSA) e.V.
Certification body accredited according to EN 45011 for security products

Certified security

Our safes comply with the high German and European security standards. They get burglar-proof and fire tested by well-known and independent test institutes and bear the respective test badge.



Contents

Page	Product range	Series
2	About us	
3	Table of contents	
4	Table of contents	
5	Burglar-proof safes	
6	Burglar-proof safes	HTS1 041
7	Burglar-proof safes	K 102 HTB 035
8	Burglar-proof safes	HTN 050
9	Burglar-proof safes	HTI 100
10	Burglar-proof safes	T 105
11	Burglar-proof safes	HTII 200
12	Burglar-proof safes	HTIII 300
13	Burglar-proof safes	HTIV 400 HTIV KB 400
14	Burglar-proof safes	HTV 500 HTV KB 500
15	Burglar and fire-proof safes	
16	Burglar and fire-proof safes	D 106
17	Burglar and fire-proof safes	D 107
18	Burglar and fire-proof safes	D 109
19	Burglar and fire-proof safes	D 111
20	Burglar and fire-proof safes	HTFIII 320
21	Burglar and fire-proof safes	HE 10
22	Burglar and fire-proof safes	HRS 46
23	Burglar and fire-proof safes	D 112
25	Filing cabinets	
26	Single-walled filing cabinets	HTF AP HTF MP
27	Single-walled filing cabinets	HTF PP HTF SP
28	Double-walled fire-protected filing cabinets	SD SDP
29	Fire-protected suspension file drawer cabinets	HTH 220
29	Double-walled fire-protected suspension file drawer cabinets	HTH 230
30	Testing procedures for fire-proof and fire-protected safes	

Page	Product range	Series
31	Data media safes	
32	Data media safes	D 125-06
33	Data media safes	D 125
34	Vertical data media safes	HTFA 080/HTFA 081 HTFI 180/HTFI 181
35	Vertical data media safes	HTFII 280 HTFIII 380
37	Furniture safes	
38	Furniture safes	HPKT 300 HPKT 400
39	Burglar-proof furniture safes	F 103
40	Burglar and fire-proof furniture safes	HPKTF 300 HPKTF 400
41	Wall and floor safes	
42	Wall safes	MS 100
43	Wall safes	S 101
44	Floor safes	HTS 132 HTS 133
45	Key safes	
46	Key boxes	HS 511
46	Emergency key boxes	HTS 100
47	Key cabinets	HTS 104 HTS 105
48	Key cabinets	HTS 107 HTS 108
49	Key cabinets	HTS 110 HTS 122
50	Key safes – solid construction	HPST 120 HTS 117
51	Key safes – solid construction	HTS 118 HTS 113
52	Key safes	HTS 114 HTS 115
53	Wall key safes	HTS 111 HTS 112
54	Key safes	HTS 119 HTS 120
55	Key safes	HTS 116 HTS 121
56	„Last“-key containers	HTS 101
56	Key control and key management system	HTS 320

Contents

Page	Product range	Series
57	Deposit and drop-down safes	
58	Drop-down safes	HS 510
59	Drop-down safes	SP HTDPB 100
60	Drawer safes	HTDPI HTDPPII
61	Drawer safes	HTDPPIII
62	Drawer safes Deposit safes	HPDI HPDII
63	Deposit safes	HPDIV
64	Deposit safes	HTDTI HTDTII
65	Deposit safes	HTDTIII
67	Strongroom doors	
68	Strongroom doors	HPT HPTB
69	Strongroom doors	HPTN HPTV
70	Strongroom doors	HPTV HPTVB
71	Strongroom doors	HPTII HPTIII 2111
72	Strongroom doors	HPTIII
Special series and accessories		
73	Components of a burglar alarm system (BAS)	
74	Locking technology	
76	Exclusive Line	
78	Bullet-proof safes	
80	Special safes	
82	Security grades — insurance cover	
84	Transport questionnaire	
85	Fax sheet	
86	Some references	

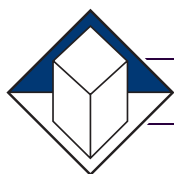

security at your service!



HARTMANN *Burglar-proof safes*

We offer burglar-proof safes at all required security levels! Right from the single-walled steel cabinet to the multi-ton high-security safe – and this all in line with what you require.

Certified burglar protection for private and business use.

■ Burglar-proof safes

- | | |
|----------------------|-------------------|
| ■ SERIES HTS1 041 | Security level S1 |
| ■ SERIES K 102 | Security level B |
| ■ SERIES HTB 035 | Security level B |
| ■ SERIES HTN 050 | VdS class N (0) |
| ■ SERIES HTI 100 | VdS class I |
| ■ SERIES T 105 | VdS class II |
| ■ SERIES HTII 200 | VdS class II |
| ■ SERIES HTIII 300 | VdS class III |
| ■ SERIES HTIV 400 | VdS class IV |
| ■ SERIES HTIV KB 400 | VdS class IV KB |
| ■ SERIES HTV 500 | VdS class V |
| ■ SERIES HTV KB 500 | VdS class V KB |



Burglar-proof safes

Series HTS1 041

Security level S1 burglar protection according to VdS 2862 EN 14450

Construction

- Double-walled door 65 mm
- Door leaf 6 mm
- All-round single-walled corpus 3 mm
- Trilateral locking device
- All-round fire fold
- Fixture for floor anchorage

Basic configuration

- Single door: DIN right-hinged door
- Double door: DIN right or left-hinged door
- Height adjustable compartment shelves (see table)
- Lacquered finish RAL 7035 light grey

Lock

- Double-bit security lock (incl. 2 keys)

Insurance cover

Security level S1 according to EN 14450

Up to € 5,000.00* private

Up to € 2,500.00* commercial



HTS1 041-03

Series HTS1 041	Ext. dimensions H x W x D (in mm)	Interior dimensions H x W x D (in mm)	Weight (in kg)	Volume (in litres)	No. shelves	No. doors
HTS1 041-01	330 x 330 x 250	324 x 324 x 185	20	19	1	1
HTS1 041-02	430 x 330 x 250	424 x 324 x 185	24	25	1	1
HTS1 041-03	280 x 450 x 365	274 x 444 x 300	29	36	1	1
HTS1 041-04	350 x 450 x 365	344 x 444 x 300	30	46	1	1
HTS1 041-05	450 x 500 x 365	444 x 494 x 300	38,5	66	1	1
HTS1 041-06	700 x 500 x 365	694 x 494 x 300	55	103	1	1
HTS1 041-07	900 x 500 x 365	894 x 494 x 300	75	132	2	1
HTS1 041-08	1200 x 500 x 365	1194 x 494 x 300	90	177	3	1
HTS1 041-09	1500 x 500 x 365	1494 x 494 x 300	95	221	3	1
HTS1 041-10	800 x 750 x 500	794 x 744 x 435	98	257	2	1
HTS1 041-11	1000 x 750 x 500	994 x 744 x 435	112	322	2	1
HTS1 041-12	1300 x 750 x 500	1294 x 744 x 435	130	419	3	1
HTS1 041-13	1600 x 750 x 500	1594 x 744 x 435	150	516	3	1
HTS1 041-14	1950 x 750 x 500	1944 x 744 x 435	210	629	4	1
HTS1 041-15	1950 x 950 x 500	1944 x 944 x 435	271	798	4	1
HTS1 041-16	1000 x 1000 x 500	994 x 994 x 435	142,0	430	2	2
HTS1 041-17	1500 x 1000 x 500	1494 x 994 x 435	199,0	646	3	2
HTS1 041-18	1800 x 1000 x 500	1794 x 994 x 435	232,0	776	3	2
HTS1 041-19	1950 x 1000 x 500	1944 x 994 x 435	249,0	841	4	2
HTS1 041-20	1200 x 1260 x 500	1194 x 1254 x 435	201,0	651	3	2
HTS1 041-21	1950 x 1260 x 500	1944 x 1254 x 435	304,0	1060	4	2

HARTMANN safe pedestals
ease the day-to-day use of your safe thanks
to offering a comfortable height.



The pedestals are also available for
safes from other series.
Simply ask us for more details.

* The insurance sums specified are reference values only.

Burglar-proof safes

Series K 102 and HTB 035

Security level B burglar protection according to VDMA 24992 05/95

Construction

- Double-walled door 80 mm
- Door leaf 6 mm
- All-round double-walled corpus 60 mm
- Trilateral locking device
- Bolt diameter Ø 25 mm

Basic configuration

- DIN right-hinged door
- Height adjustable compartment shelves (see table)
- Lacquered finish RAL 7035 light grey

Lock

- Double-bit security lock (incl. 2 keys)

Insurance cover

Security level B according to VDMA 24992

€ 2,500.00* commercial/private up to 200 kg

Up to € 10,000.00* commercial from 300 kg

Up to € 40,000.00* private from 200 kg



Series K 102	Ext. dimensions H x W x D (in mm)	Interior dimensions H x W x D (in mm)	Weight (in kg)	Volume (in litres)	No. shelves
K 102-08	480 x 475 x 450	360 x 340 x 310	200	38	1
K 102-09	655 x 475 x 450	535 x 340 x 310	200	56	1
K 102-10	855 x 475 x 450	735 x 340 x 310	200	78	2
K 102-11	855 x 475 x 450	735 x 340 x 310	300	78	2
K 102-12	800 x 610 x 510	680 x 430 x 390	200	114	2
K 102-13	1200 x 610 x 510	1080 x 430 x 390	300	181	2
K 102-17	800 x 650 x 500	680 x 520 x 360	200	128	2
K 102-18	800 x 650 x 500	680 x 520 x 360	300	128	1
K 102-19	1000 x 650 x 500	880 x 520 x 360	200	165	1
K 102-20	1000 x 650 x 500	880 x 520 x 360	300	165	1
K 102-21	1200 x 650 x 500	1080 x 520 x 360	200	202	2
K 102-22	1200 x 650 x 500	1080 x 520 x 360	300	202	2
K 102-24	1500 x 650 x 510	1373 x 520 x 360	300	256	3
K 102-26	1800 x 650 x 510	1674 x 520 x 360	350	312	3
Series HTB 035	Ext. dimensions H x W x D (in mm)	Interior dimensions H x W x D (in mm)	Weight (in kg)	Volume (in litres)	No. shelves
HTB 035-01	465 x 500 x 430	330 x 370 x 300	200	37	1
HTB 035-02	665 x 500 x 430	530 x 370 x 300	200	59	2
HTB 035-03	865 x 500 x 430	730 x 370 x 300	200	81	2
HTB 035-04	990 x 500 x 430	855 x 370 x 300	200	95	2
HTB 035-05	665 x 500 x 430	530 x 370 x 300	300	59	2
HTB 035-06	865 x 500 x 430	730 x 370 x 300	300	81	2
HTB 035-07	990 x 500 x 430	855 x 370 x 300	300	95	3
HTB 035-08	1300 x 500 x 430	1180 x 370 x 300	300	131	3
HTB 035-09	1600 x 500 x 430	1480 x 370 x 300	300	164	3

Burglar-proof safes

Series HTN 050

Euro resistance grade VdS class N (O) burglar protection according to EN 1143-1

Construction

- Multi-walled door 105 mm
- Drill-proof armoured plating in door and lock area
- All-round multi-walled corpus
- Door and corpus filled with high-quality fire-resistant insulation
- Solid bolt locking system
- Burglar-proof tested 30/30 RU
- Fixture for floor anchorage
- Protruding fittings and hinges at 60 mm

Basic configuration

- Single door: DIN right-hinged door
- Double door: DIN right / left-hinged door
- Compartment shelves (see table)
- Door opening angle of 180°
- Lacquered finish RAL 7035 light grey

Lock

- Double-bit security lock (incl. 2 keys)

Insurance cover

Resistance grade VdS class N (O)

€ 10,000.00 ^{*/**} commercial

€ 40,000.00 ^{*/**} private



HTN 050-09

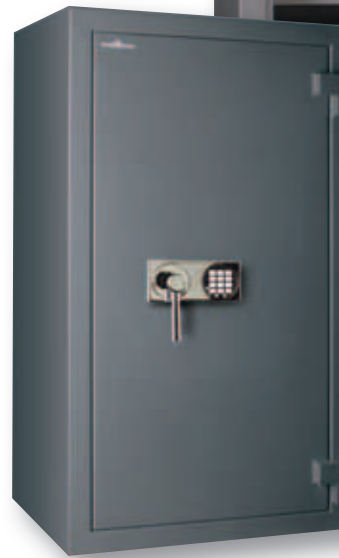

Series HTN 050	Ext. dimensions H x W x D (in mm)	Interior dimensions H x W x D (in mm)	Weight (in kg)	Volume (in litres)	No. shelves	No. doors
HTN 050-01	514 x 604 x 400	375 x 468 x 230	90	40	1	1
HTN 050-02	606 x 636 x 510	467 x 500 x 340	134	79	1	1
HTN 050-03	806 x 636 x 510	667 x 500 x 340	170	113	2	1
HTN 050-04	800 x 700 x 550	661 x 564 x 380	178	142	2	1
HTN 050-05	906 x 636 x 510	767 x 500 x 340	180	130	2	1
HTN 050-06	1006 x 636 x 510	867 x 500 x 340	191	147	2	1
HTN 050-07	1006 x 836 x 600	867 x 700 x 430	264	261	2	1
HTN 050-08	1206 x 636 x 510	1067 x 500 x 340	231	181	3	1
HTN 050-09	1250 x 700 x 550	1111 x 564 x 380	261	238	3	1
HTN 050-10	1256 x 836 x 600	1117 x 700 x 430	298	336	3	1
HTN 050-11	1500 x 700 x 550	1361 x 564 x 380	306	292	3	1
HTN 050-12	1506 x 806 x 550	1367 x 670 x 380	310	348	3	1
HTN 050-13	1506 x 836 x 600	1367 x 700 x 430	337	411	3	1
HTN 050-14	1806 x 806 x 550	1667 x 670 x 380	356	424	4	1
HTN 050-15	1806 x 836 x 600	1667 x 700 x 430	389	502	4	1
HTN 050-16	1806 x 1200 x 600	1667 x 1064 x 430	567	763	4	2
HTN 050-17	1806 x 1486 x 550	1667 x 1350 x 380	629	855	4	2
HTN 050-18	1950 x 700 x 550	1811 x 564 x 380	351	388	4	1
HTN 050-19	1950 x 950 x 550	1811 x 814 x 380	490	560	4	2
HTN 050-20	1950 x 1260 x 550	1811 x 1124 x 380	600	774	4	2

**Now available
in LFS 30P**
tested and certified
according to EN 15659

* The insurance sums specified are reference values only.

** The insurance sum will double if a VdS recognized burglar alarm system (BAS) is connected.

Burglar-proof safes

Series HTI 100

Euro resistance grade VdS class I burglar protection according to EN 1143-1

Construction

- Multi-walled door 105 mm
- Drill-proof armoured plating in door and lock area
- All-round multi-walled corpus
- Door and corpus filled with high-quality fire-resistant insulation
- Solid bolt locking system
- Burglar-proof tested 30/50 RU
- Fixture for floor anchorage
- Protruding fittings and hinges at 60 mm

Basic configuration

- Single door: DIN right-hinged door
- Double door: DIN right / left-hinged door
- Height adjustable compartment shelves (see table)
- Door opening angle of 180°
- Lacquered finish RAL 7035 light grey

Lock

- Double-bit security lock (incl. 2 keys)

Insurance cover

Resistance grade VdS I

€ 20,000.00 *** commercial / € 65,000.00 *** private



HTI 100-09

Optional: with a special deposit system as a top piece or deposit shaft through a wall

Series HTI 100	Ext. dimensions H x W x D (in mm)	Interior dimensions H x W x D (in mm)	Weight (in kg)	Volume (in litres)	No. shelves	No. doors
HTI 100-01	514 x 604 x 400	375 x 468 x 230	111	40	1	1
HTI 100-02	606 x 636 x 510	467 x 500 x 340	148	80	1	1
HTI 100-03	800 x 700 x 550	661 x 564 x 380	202	142	2	1
HTI 100-04	806 x 636 x 510	667 x 500 x 340	180	113	2	1
HTI 100-05	906 x 636 x 510	767 x 500 x 340	199	130	2	1
HTI 100-06	1006 x 636 x 510	867 x 500 x 340	216	147	2	1
HTI 100-07	1006 x 836 x 600	867 x 700 x 430	285	261	2	1
HTI 100-08	1206 x 636 x 510	1067 x 500 x 340	249	181	3	1
HTI 100-09	1250 x 700 x 550	1111 x 564 x 380	284	238	3	1
HTI 100-10	1256 x 836 x 600	1117 x 700 x 430	337	336	3	1
HTI 100-11	1500 x 700 x 550	1361 x 564 x 380	329	292	3	1
HTI 100-12	1506 x 806 x 550	1367 x 670 x 380	336	348	3	1
HTI 100-13	1506 x 836 x 600	1367 x 700 x 434	385	411	3	1
HTI 100-14	1806 x 806 x 550	1667 x 670 x 380	422	424	4	1
HTI 100-15	1806 x 840 x 600	1667 x 700 x 430	452	502	4	1
HTI 100-16	1806 x 1200 x 600	1667 x 1064 x 430	576	763	4	2
HTI 100-17	1806 x 1486 x 550	1667 x 1350 x 380	648	855	4	2
HTI 100-18	1950 x 700 x 550	1811 x 564 x 380	412	388	4	1
HTI 100-19	1950 x 950 x 550	1811 x 814 x 380	501	560	4	2
HTI 100-20	1950 x 1260 x 550	1811 x 1124 x 380	626	774	4	2

**Now available
in LFS 30P
tested and certified
according to EN 15659**

Burglar-proof safes

Series HTII 200

Euro resistance grade VdS class II burglar protection according to EN 1143-1

■ Construction

- Multi-walled door 114 mm
- Armoured drill-safeguarded plating in lock area
- All-round multi-walled corpus
- Door and corpus filled with special high-strength fire-resistant insulation and concrete filling
- Solid bolt locking system
- Burglar-proof tested 50/80 RU
- Fixture for floor anchorage
- Protruding fittings and hinges at 60 mm

■ Basic configuration

- Single-door: DIN right-hinged door
- Double-door: DIN right / left-hinged door
- Height adjustable compartment shelves (see table)
- Door opening angle of 180°
- Lacquered finish RAL 7035 light grey

■ Lock

- Double-bit security lock (incl. 2 keys)

■ Insurance cover

Resistance grade VdS II

€ 50,000.00^{*/**} commercial / € 100,000.00^{*/**} private



HTII 200-05

Optional: with a special deposit system as a top piece or deposit shaft through a wall

Series HTII 200	Ext. dimensions H x W x D (in mm)	Interior dimensions H x W x D (in mm)	Weight (in kg)	Volume (in litres)	No. shelves	No. doors
HTII 200-01	514 x 604 x 400	395 x 488 x 234	232	45	1	1
HTII 200-02	606 x 636 x 510	487 x 520 x 344	316	87	1	1
HTII 200-03	800 x 700 x 550	681 x 584 x 384	446	153	2	1
HTII 200-04	806 x 636 x 510	687 x 520 x 344	397	123	2	1
HTII 200-05	906 x 636 x 510	787 x 520 x 344	435	141	2	1
HTII 200-06	1006 x 636 x 510	887 x 520 x 345	473	159	2	1
HTII 200-07	1006 x 836 x 600	887 x 720 x 434	639	277	2	1
HTII 200-08	1206 x 636 x 510	1087 x 520 x 344	552	194	3	1
HTII 200-09	1250 x 700 x 550	1131 x 584 x 384	637	254	3	1
HTII 200-10	1256 x 836 x 600	1137 x 720 x 434	765	355	3	1
HTII 200-11	1500 x 700 x 550	1381 x 584 x 384	741	310	3	1
HTII 200-12	1506 x 806 x 550	1387 x 690 x 384	824	367	3	1
HTII 200-13	1506 x 836 x 600	1387 x 720 x 434	858	433	3	1
HTII 200-14	1806 x 806 x 550	1687 x 690 x 384	945	447	4	1
HTII 200-15	1806 x 836 x 600	1687 x 720 x 434	919	527	4	1
HTII 200-16	1806 x 1200 x 600	1687 x 1084 x 434	1371	794	4	2
HTII 200-17	1806 x 1486 x 550	1687 x 1370 x 384	1485	887	4	2
HTII 200-18	1950 x 700 x 550	1831 x 584 x 384	931	411	4	1
HTII 200-19	1950 x 950 x 550	1831 x 834 x 384	1175	586	4	2
HTII 200-20	1950 x 1260 x 550	1831 x 1144 x 384	1457	804	4	2

**Now available
in LFS 30P
tested and certified
according to EN 15659**

Burglar-proof safes

Series HTIII 300

Euro resistance grade VdS class III burglar protection according to EN 1143-1

Construction

- All-round multi-walled door and corpus
- Filled with high-strength concrete for safes
- Armoured drill-safeguarded plating in lock area
- Overall door thickness 137 mm with a trilateral bolt locking system and additional run-through rear grip section
- The closing and locking system protects against grave burglar attempts; any attempts will additionally activate and emergency locking mechanism on the door
- Burglar-proof tested 80/120 RU
- Fixture for floor anchorage incl. mounting material

Insurance cover

Resistance grade VdS III

€ 100,000.00^{*/**} commercial

€ 200,000.00^{*/**} private

Basic configuration

- Single-door: DIN right-hinged door
- Double-door: DIN right / left-hinged door
- Height adjustable compartment shelves (see table)
- Door opening angle of 180°
- High-quality fittings
- Prepared for installation of recognized burglar alarm system components ready for connection to a burglar alarm system
- Lacquered finish RAL 7035 light grey
- Lock**
- Double-bit security lock (incl. 2 keys)

Optional: with a special deposit system as a top piece or deposit shaft through a wall

Prepared with components ready for the installation of recognized burglar alarm system (see page 73 for more details)



HTIII 300-05

Series HTIII 300	Ext. dimensions H x W x D (in mm)	Interior dimensions H x W x D (in mm)	Weight (in kg)	Volume (in litres)	No. shelves	No. doors
HTIII 300-01	606 x 636 x 510	456 x 504 x 304	354	70	1	1
HTIII 300-02	800 x 700 x 550	650 x 568 x 344	499	127	2	1
HTIII 300-03	806 x 636 x 510	656 x 504 x 304	447	101	2	1
HTIII 300-04	906 x 636 x 510	756 x 504 x 304	492	116	2	1
HTIII 300-05	1006 x 636 x 510	856 x 504 x 304	536	132	2	1
HTIII 300-06	1006 x 836 x 700	856 x 704 x 494	769	298	2	1
HTIII 300-07	1210 x 640 x 510	1056 x 504 x 304	633	162	3	1
HTIII 300-08	1250 x 700 x 550	1100 x 568 x 344	721	216	3	1
HTIII 300-09	1256 x 836 x 700	1106 x 704 x 494	917	385	3	1
HTIII 300-10	1500 x 700 x 550	1350 x 568 x 344	848	265	3	1
HTIII 300-11	1510 x 810 x 550	1356 x 674 x 344	936	315	3	1
HTIII 300-12	1506 x 836 x 700	1356 x 704 x 494	1067	473	3	1
HTIII 300-13	1806 x 806 x 550	1656 x 674 x 344	1100	385	4	1
HTIII 300-14	1806 x 836 x 700	1656 x 704 x 494	1245	577	4	1
HTIII 300-15	1806 x 1200 x 700	1656 x 1068 x 494	1635	891	4	2
HTIII 300-16	1806 x 1486 x 550	1656 x 1354 x 344	1774	790	4	2
HTIII 300-17	1950 x 700 x 550	1800 x 568 x 344	1019	353	4	1
HTIII 300-18	1950 x 950 x 550	1800 x 818 x 344	1122	508	4	2
HTIII 300-19	1950 x 1260 x 550	1800 x 1128 x 344	1541	715	4	2

* The insurance sums specified are reference values only.

** The insurance sum will double if a VdS recognized burglar alarm system (BAS) is connected.

**Now available
in LFS 30P
tested and certified
according to EN 15659**

Burglar-proof safes

Series HTIV 400 and HTIV KB 400

Euro resistance grade VdS class IV und IV KB burglar protection according to EN 1143-1

Construction

- Multi-walled door 150 mm
- Trilateral walled safe corpus
- Filled with high-strength filling and with strengthened wall construction for higher resistance grades
- With welding and blowtorch safeguard in lock area
- Solid 40 mm round steel bolts
- Special armoured plating of the locking mechanism
- Solid steel rear grip bolts
- Additional drill safeguarded bolts at all locking points
- Emergency locking mechanism
- Burglar-proof tested 120/180 RU ('KB)
- KB: with core drill safeguard

Basic configuration

- 20 mm grid division of the interior
- DIN right-hinged door
- Height adjustable compartment shelves (see table)
- Door opening angle of 180°
- Fixture for floor anchorage incl. mounting material
- Standard: prepared drill hole for lead out cable and two mounting plates (housing/door) for mechanical vibration alarm
- Lacquered finish RAL 7035 light grey

Lock

- Double-bit security lock (incl. 3 keys)
- Standard: additional mechanical combination lock

Insurance cover

Resistance grade VdS IV

€ 150,000.00^{*/**} commercial

€ 400,000.00^{*/**} private

Resistance grade VdS IV 'KB

€ 250,000.00^{*/**} commercial/private^{**}

Prepared with components ready for the installation of recognized burglar alarm system (see page 73 for more details)



All models of the HTIV 400 series are also available with core drill protection

Series HTIV 400	Ext. dimensions H x W x D (in mm)	Interior dimensions H x W x D (in mm)	Weight (in kg)/KB ¹	Volume (in litres)	No. shelves	No. doors
HTIV 400-01	860 x 620 x 580	680 x 450 x 340	550/560 ¹	104	1	1
HTIV 400-02	1030 x 620 x 580	850 x 450 x 340	630/650 ¹	130	2	1
HTIV 400-03	1200 x 620 x 580	1020 x 450 x 340	690/720 ¹	156	2	1
HTIV 400-04	1200 x 825 x 700	1020 x 655 x 460	960/980 ¹	307	2	1
HTIV 400-05	1380 x 825 x 700	1200 x 655 x 460	1100/1130 ¹	362	3	1
HTIV 400-06	1730 x 825 x 700	1550 x 655 x 460	1290/1340 ¹	467	4	1
HTIV 400-07	1800 x 1190 x 730	1620 x 1020 x 490	1670/1740 ¹	810	4	1

¹ KB: with core drill safeguard

* The insurance sum will double if a VdS recognized burglar alarm system (BAS) is connected

**The insurance coverage is to be specified with the respective authorised expert.

Burglar-proof safes

Series HTV 500 and HTV KB 500

Euro resistance grade VdS class V and V KB burglar protection according to EN 1143-1
Construction

- Trilateral walled safe corpus mit Spezialfüllung und Verstärkung
- Trilateral walled door with drill and blowtorch safeguard
- With welding and blowtorch safeguard in lock area
- Solid 40 mm round steel bolts
- Special armoured plating of the locking mechanism
- Solid steel rear grip bolts
- Additional drill safeguarded bolts at all locking points
- Emergency locking mechanism
- Burglar-proof tested 180/270 RU ('KB)
- KB: with core drill safeguard

Basic configuration

- 20 mm Grid division of the interior
- DIN right-hinged door
- Height adjustable compartment shelves (see table)
- Door opening angle of 180°
- Fixture for floor anchorage incl. mounting material (under 1000 kg)
- Standard: prepared drill hole for lead out cable and two mounting plates (housing/door) for mechanical vibration alarm
- Lacquered finish RAL 7035 light grey

Lock

- Double-bit security lock (incl. 3 keys)
- Standard: additional mechanical combination lock

Insurance cover

Resistance grade VdS V

 € 250,000.00^{*/**} commercial/private^{**}

Resistance grade VdS V 'KB

 € 375,000.00^{*/**} commercial/private^{**}

Prepared with components ready for the installation of recognized burglar alarm system (see page 73 for more details)



HTV 500-02

All models of the HTV 500 series are also available with core drill safeguard

Series HTV 500	Ext. dimensions H x W x D (in mm)	Interior dimensions H x W x D (in mm)	Weight (in kg)/KB ¹	Volume (in litres)	No. shelves	No. doors
HTV 500-01	860 x 620 x 580	680 x 450 x 340	610/650 ¹	104	1	1
HTV 500-02	1030 x 620 x 580	850 x 450 x 340	690/740 ¹	130	2	1
HTV 500-03	1200 x 620 x 580	1020 x 450 x 340	770/830 ¹	156	2	1
HTV 500-04	1200 x 825 x 700	1020 x 655 x 460	1020/1104 ¹	307	2	1
HTV 500-05	1380 x 825 x 700	1200 x 655 x 460	1180/1320 ¹	362	3	1
HTV 500-06	1730 x 825 x 700	1550 x 655 x 460	1400/1580 ¹	467	4	1
HTV 500-07	1800 x 1190 x 730	1620 x 1020 x 490	1810/2060 ¹	810	4	1

¹ KB: with core drill safeguard

* The insurance sum will double if a VdS recognized burglar alarm system (BAS) is connected.

**The insurance coverage is to be specified with the respective authorised expert.



HARTMANN *Burglar and fire-proof safes*

Apart from offering protection against burglary, fire-proof safes offer important security in the event of fire. Most companies and private individuals often think about this double risk when it is too late. We offer so-called duplex cabinets of different fire protection classes and burglar-proof classes. The safes get successfully fire and drop tested at the Institute for Material Testing at the University of Technology in Braunschweig (MPA) and get awarded respective test badges. Please see page 30 and 31 for more.

Double security thanks to certified burglar and fire protection

You will find more fire-proof safes that can protect sensitive data carriers from heat under data media safes from page 31.

■ **Burglar and fire-proof safes**

- **SERIES D 106** Security level B/S 60P
- **SERIES D 107** VdS class N (0)/S 60 P
- **SERIES D 109** VdS class I/S 60 P
- **SERIES D 111** VdS class II/S 60 P
- **SERIES HTFIII 320** VdS class III/S 60 P
- **SERIES HE 10** Security level B/S 120P
- **SERIES HRS 46** VdS class I/S 120 P
- **SERIES D 112** VdS class II/S 120 P



BURGLAR PROTECTION



FIRE PROTECTION

Burglar and fire-proof safes

Series D 106

Security level B according to VDMA 24992 05/95

Quality grade S 60 P fire proof according to EN 1047-1

Construction

- Door thickness 95 mm
- Multi-walled corpus
- Fire-proof quality material insulation of the safe corpus
- Additional protection via quadrilateral all-round fire fold
- Fixture for floor anchorage

Basic configuration

- Single-door: DIN right-hinged door
- Double-door: DIN right / left-hinged door
- Door opening angle of 180°
- Height adjustable compartment shelves (see table)
- Lacquered finish RAL 7035 light grey

Lock

- Double-bit security lock (incl. 2 keys)

Insurance cover

Security level B according to VDMA 24992

€ 2,500.00* commercial/private up to 200 kg

Up to € 10,000.00**/*** commercial from 300 kg

Up to € 40,000.00**/*** private from 200 kg

**Fire protection
60 minutes**

Fire-proof sideboard!

Available in all RAL colours
to match your office furniture

Ideal for in the office!

Optional from model **D 106-08**:
especially fire-resistant compartment
inserts for data carriers

Series D 106	Ext. dimensions H x W x D (in mm)	Interior dimensions H x W x D (in mm)	Weight (in kg)	Volume (in litres)	No. shelves	No. doors	Series D 106	Ext. dimensions H x W x D (in mm)	Interior dimensions H x W x D (in mm)	Weight (in kg)	Volume (in litres)	No. shelves	No. doors
D 106-01	380 x 465 x 430	280 x 350 x 295	90	31	1	1	D 106-20	1884 x 1292 x 459	1785 x 1170 x 290	765	650	4	2
D 106-02	440 x 465 x 430	340 x 350 x 295	99	38	1	1	D 106-21	1884 x 1292 x 559	1785 x 1170 x 390	805	864	4	2
D 106-03	615 x 465 x 430	515 x 350 x 295	118	57	1	1	D 106-22	1884 x 1292 x 696	1785 x 1170 x 530	860	1158	4	2
D 106-04	775 x 465 x 430	675 x 350 x 270	160	74	2	1	D 106-30	900 x 980 x 460	800 x 865 x 290	336	206	1	2
D 106-05	1135 x 705 x 470	1035 x 595 x 320	270	215	2	1	D 106-31	900 x 980 x 560	800 x 865 x 390	355	277	1	2
D 106-06	1320 x 705 x 470	1222 x 595 x 320	305	253	3	1	D 106-32	900 x 1130 x 460	800 x 1015 x 290	363	243	1	2
D 106-07	1510 x 705 x 470	1410 x 595 x 320	340	291	3	1	D 106-33	900 x 1130 x 560	800 x 1015 x 390	394	325	1	2
D 106-08	1550 x 886 x 545	1450 x 775 x 390	452	464	3	1	D 106-34	900 x 1280 x 460	800 x 1170 x 290	399	279	1	2
D 106-09	1550 x 886 x 445	1450 x 775 x 290	417	349	3	1	D 106-35	900 x 1280 x 560	800 x 1170 x 390	433	374	1	2
D 106-10	1700 x 886 x 545	1600 x 775 x 390	488	512	4	1	D 106-36	1050 x 980 x 510	945 x 865 x 340	373	279	2	2
D 106-11	1700 x 886 x 445	1600 x 775 x 290	448	385	4	1	D 106-37	1050 x 1130 x 510	945 x 1015 x 340	414	329	2	2
D 106-12	1884 x 886 x 545	1785 x 775 x 390	527	570	4	1	D 106-38	1050 x 1280 x 510	950 x 1170 x 340	455	378	2	2
D 106-13	1884 x 886 x 445	1785 x 774 x 290	487	428	4	1	D 106-39	1190 x 980 x 460	1090 x 865 x 290	390	281	2	2
D 106-14	1884 x 975 x 459	1785 x 865 x 290	598	477	4	2	D 106-40	1190 x 980 x 560	1090 x 865 x 390	424	376	2	2
D 106-15	1884 x 975 x 559	1785 x 865 x 390	634	634	4	2	D 106-41	1190 x 1130 x 460	1090 x 1015 x 290	434	330	2	2
D 106-16	1884 x 975 x 696	1785 x 865 x 530	683	850	4	2	D 106-42	1190 x 1130 x 560	1090 x 1015 x 390	469	442	2	2
D 106-17	1884 x 1128 x 459	1785 x 1015 x 290	679	560	4	2	D 106-43	1190 x 1280 x 460	1090 x 1170 x 290	477	380	2	2
D 106-18	1884 x 1128 x 559	1785 x 1015 x 390	717	745	4	2	D 106-44	1190 x 1280 x 560	1090 x 1170 x 390	516	508	2	2
D 106-19	1884 x 1128 x 696	1785 x 1015 x 530	768	999	4	2							

* The insurance sums specified are reference values only.

** The insurance sum will double if a VdS recognized burglar alarm system (BAS) is connected.

Burglar and fire-proof safes

Series D 107

Euro resistance grade VdS class N (0) burglar protection according to EN 1143-1

Quality grade S 60 P fire proof according to EN 1047-1

Construction

- Door thickness 90 mm
- All-round multi-walled corpus and door
- All-round bolt locking system
- Protruding fittings and hinges at 60 mm
- Fixture for floor anchorage

Basic configuration

- Single-door: DIN right-hinged door
- Double-door: DIN right / left-hinged door
- Door opening angle of 180°
- Height adjustable compartment shelves (see table)
- Lacquered finish RAL 7035 light grey

Lock

- Double-bit security lock (incl. 2 keys)

Insurance cover

Resistance grade VdS N (0)

€ 10,000.00^{*/**} commercial

€ 40,000.00^{*/**} private



D 107-05

Optional from model D 107-12:
fire-resistant disc insert S 60 DIS

Series D 107	Ext. dimensions H x W x D (in mm)	Interior dimensions H x W x D (in mm)	Weight (in kg)	Volume (in litres)	No. shelves	No. doors	Series D 107	Ext. dimensions H x W x D (in mm)	Interior dimensions H x W x D (in mm)	Weight (in kg)	Volume (in litres)	No. shelves	No. doors
D 107-01	380 x 590 x 470	295 x 490 x 320	125	49	1	1	D 107-22	1884 x 1128 x 559	1799 x 1028 x 403	785	745	4	2
D 107-02	480 x 590 x 470	400 x 490 x 320	140	67	1	1	D 107-23	1884 x 1128 x 696	1799 x 1028 x 540	846	999	4	2
D 107-03	615 x 590 x 470	530 x 490 x 320	160	88	2	1	D 107-24	1884 x 1292 x 459	1799 x 1192 x 303	833	650	4	2
D 107-04	800 x 590 x 470	720 x 490 x 320	210	120	2	1	D 107-25	1884 x 1292 x 559	1799 x 1192 x 403	880	864	4	2
D 107-05	1140 x 705 x 470	1050 x 605 x 320	315	216	3	1	D 107-26	1884 x 1292 x 696	1799 x 1192 x 540	945	1158	4	2
D 107-06	1320 x 705 x 470	1240 x 605 x 320	340	255	3	1	D 107-30	900 x 980 x 460	800 x 865 x 295	366	204	1	2
D 107-07	1510 x 705 x 470	1420 x 605 x 320	375	292	3	1	D 107-31	900 x 980 x 560	800 x 865 x 395	388	273	1	2
D 107-08	380 x 465 x 440	295 x 365 x 295	98	32	1	1	D 107-32	900 x 1130 x 460	800 x 1015 x 295	395	239	1	2
D 107-09	440 x 465 x 440	355 x 365 x 295	105	38	1	1	D 107-33	900 x 1130 x 560	800 x 1015 x 395	430	320	1	2
D 107-10	615 x 465 x 440	530 x 365 x 295	140	57	2	1	D 107-34	900 x 1280 x 460	800 x 1175 x 295	436	277	1	2
D 107-11	775 x 465 x 440	693 x 365 x 295	158	75	2	1	D 107-35	900 x 1280 x 560	800 x 1175 x 395	472	371	1	2
D 107-12	1550 x 886 x 545	1465 x 786 x 403	501	464	3	1	D 107-36	1050 x 980 x 510	950 x 865 x 350	406	287	2	2
D 107-13	1550 x 886 x 445	1465 x 786 x 303	466	349	3	1	D 107-37	1050 x 1130 x 510	950 x 1015 x 350	452	337	2	2
D 107-14	1700 x 886 x 545	1615 x 786 x 403	539	512	4	1	D 107-38	1050 x 1280 x 510	950 x 1175 x 350	492	390	2	2
D 107-15	1700 x 886 x 445	1615 x 786 x 303	502	385	4	1	D 107-39	1190 x 980 x 460	1090 x 865 x 295	425	278	2	2
D 107-16	1884 x 886 x 545	1799 x 786 x 403	586	570	4	1	D 107-40	1190 x 980 x 560	1090 x 865 x 395	463	372	2	2
D 107-17	1884 x 886 x 445	1799 x 786 x 303	545	428	4	1	D 107-41	1190 x 1130 x 460	1090 x 1015 x 295	472	326	2	2
D 107-18	1884 x 975 x 459	1799 x 875 x 303	653	477	4	1	D 107-42	1190 x 1130 x 560	1090 x 1015 x 395	517	437	2	2
D 107-19	1884 x 975 x 559	1799 x 875 x 403	696	634	4	1	D 107-43	1190 x 1280 x 460	1090 x 1175 x 295	520	378	2	2
D 107-20	1884 x 975 x 696	1799 x 875 x 540	753	850	4	1	D 107-44	1190 x 1280 x 560	1090 x 1175 x 395	563	505	2	2
D 107-21	1884 x 1128 x 459	1799 x 1028 x 303	740	560	4	2							

* The insurance sums specified are reference values only.

** The insurance sum will double if a VdS recognized burglar alarm system (BAS) is connected.

Burglar and fire-proof safes

Series D 109

Euro resistance grade VdS class I burglar protection according to EN 1143-1

Quality grade S 60 P fire proof according to EN 1047-1

Construction

- Door thickness 105 mm
- Sandwiched multi-walled construction
- Extra strong construction
- Multilateral bolt locking system
- All-round fire insulation
- Fixture for floor anchorage

Basic configuration

- Single-door: DIN right-hinged door
- Double-door: DIN right / left-hinged door
- Door opening angle of 180°
- Height adjustable compartment shelves (see table)
- Lacquered finish RAL 7035 light grey

Lock

- Double-bit security lock (incl. 2 keys)

Insurance cover

Resistance grade VdS I

€ 20,000.00^{*/**} commercial

€ 65,000.00^{*/**} private



**Fire protection
60 minutes**



D 109-08 to D 109-11 are specially designed for furniture installation

Optional from model D 106-12: especially fire-resistant compartment inserts for data carriers

Series D 109	Ext. dimensions H x W x D (in mm)	Interior dimensions H x W x D (in mm)	Weight (in kg)	Volume (in litres)	No. shelves	No. doors	Series D 109	Ext. dimensions H x W x D (in mm)	Interior dimensions H x W x D (in mm)	Weight (in kg)	Volume (in litres)	No. shelves	No. doors
D 109-01	380 x 590 x 470	280 x 480 x 310	128	48	1	1	D 109-22	1884 x 1128 x 559	1783 x 1016 x 393	790	712	4	2
D 109-02	480 x 590 x 470	380 x 480 x 310	144	65	1	1	D 109-23	1884 x 1128 x 696	1783 x 1016 x 530	851	960	4	2
D 109-03	615 x 590 x 470	515 x 480 x 310	170	87	2	1	D 109-24	1884 x 1282 x 459	1783 x 1170 x 293	839	611	4	2
D 109-04	800 x 590 x 470	700 x 480 x 310	215	118	2	1	D 109-25	1884 x 1282 x 559	1783 x 1170 x 393	886	820	4	2
D 109-05	1140 x 705 x 470	1040 x 595 x 310	330	215	3	1	D 109-26	1884 x 1282 x 696	1783 x 1170 x 530	951	1106	4	2
D 109-06	1320 x 705 x 470	1220 x 595 x 310	365	253	3	1	D 109-30	900 x 980 x 460	800 x 865 x 280	375	206	1	2
D 109-07	1510 x 705 x 470	1410 x 595 x 310	395	291	3	1	D 109-31	900 x 980 x 560	800 x 865 x 380	398	277	1	2
D 109-08	380 x 465 x 440	280 x 350 x 275	105	34	1	1	D 109-32	900 x 1130 x 460	800 x 1015 x 280	403	243	1	2
D 109-09	440 x 465 x 440	340 x 350 x 275	115	40	1	1	D 109-33	900 x 1130 x 560	800 x 1015 x 380	441	325	1	2
D 109-10	615 x 465 x 440	515 x 350 x 275	145	60	2	1	D 109-34	900 x 1280 x 460	800 x 1170 x 280	447	279	1	2
D 109-11	775 x 465 x 440	675 x 350 x 275	160	79	2	1	D 109-35	900 x 1280 x 560	800 x 1170 x 380	485	374	1	2
D 109-12	1550 x 886 x 545	1449 x 774 x 403	509	452	3	1	D 109-36	1050 x 980 x 510	945 x 865 x 330	418	289	2	2
D 109-13	1550 x 886 x 445	1449 x 774 x 303	474	340	3	1	D 109-37	1050 x 1130 x 510	945 x 865 x 340	464	340	2	2
D 109-14	1700 x 886 x 545	1599 x 774 x 403	547	499	4	1	D 109-38	1050 x 1280 x 510	945 x 1170 x 330	510	391	2	2
D 109-15	1700 x 886 x 445	1599 x 774 x 303	509	375	4	1	D 109-39	1190 x 980 x 460	1090 x 865 x 280	437	281	2	2
D 109-16	1884 x 886 x 545	1783 x 774 x 403	586	557	4	1	D 109-40	1190 x 980 x 560	1090 x 865 x 380	475	376	2	2
D 109-17	1884 x 886 x 445	1783 x 774 x 303	553	418	4	1	D 109-41	1190 x 1130 x 460	1090 x 1015 x 280	486	330	2	2
D 109-18	1884 x 975 x 459	1783 x 863 x 293	659	451	4	2	D 109-42	1190 x 1130 x 560	1090 x 1015 x 380	526	442	2	2
D 109-19	1884 x 975 x 559	1783 x 863 x 393	701	605	4	2	D 109-43	1190 x 1280 x 460	1090 x 1170 x 280	535	380	2	2
D 109-20	1884 x 975 x 696	1783 x 863 x 530	759	816	4	2	D 109-44	1190 x 1280 x 560	1090 x 1170 x 380	578	508	2	2
D 109-21	1884 x 1128 x 459	1783 x 1016 x 293	746	531	4	2							

* The insurance sums specified are reference values only.

** The insurance sum will double if a VdS recognized burglar alarm system (BAS) is connected.

Burglar and fire-proof safes

Series D 111

Euro resistance grade VdS class II burglar protection according to EN 1143-1

Quality grade S 60 P fire proof according to EN 1047-1

■ Construction

- Overall door thickness 100 mm
- All-round multi-walled corpus and door
- All-round bolt locking system
- Armoured drill-safeguarded plating in lock area
- Fixture for floor anchorage

■ Basic configuration

- Single-door: DIN right-hinged door
- Double-door: DIN right / left-hinged door
- Door opening angle of 180°
- Height adjustable compartment shelves (see table)
- Lacquered finish RAL 7035 light grey

■ Lock

- Double-bit security lock (incl. 2 keys)

■ Insurance cover

Resistance grade VdS II

€ 50,000.00^{*/**} commercial

€ 100,000.00^{*/**} private

**Fire protection
60 minutes**

Optional from model **D 111-07**:
especially fire-resistant compartment
inserts for data carriers



D 111-05

Series D 111	Ext. dimensions H x W x D (in mm)	Interior dimensions H x W x D (in mm)	Weight (in kg)	Volume (in litres)	No. shelves	No. doors
D 111-01	505 x 600 x 500	365 x 460 x 320	186	53	1	1
D 111-02	635 x 600 x 500	495 x 460 x 320	230	73	2	1
D 111-03	820 x 600 x 500	680 x 460 x 320	280	100	2	1
D 111-04	1160 x 710 x 500	1020 x 570 x 320	420	187	3	1
D 111-05	1345 x 710 x 500	1205 x 570 x 320	451	221	3	1
D 111-06	1530 x 710 x 500	1390 x 570 x 320	520	255	3	1
D 111-07	1589 x 892 x 571	1465 x 768 x 394	655	443	3	1
D 111-08	1589 x 892 x 497	1465 x 768 x 320	609	360	3	1
D 111-09	1739 x 892 x 571	1615 x 768 x 394	707	489	4	1
D 111-10	1739 x 892 x 497	1615 x 768 x 320	658	397	4	1
D 111-11	1905 x 892 x 571	1781 x 768 x 394	765	539	4	1
D 111-12	1905 x 892 x 497	1781 x 768 x 320	713	438	4	1
D 111-13	1905 x 999 x 497	1781 x 875 x 320	865	500	4	2
D 111-14	1905 x 999 x 580	1781 x 875 x 403	935	628	4	2
D 111-15	1905 x 999 x 717	1781 x 875 x 540	1049	842	4	2
D 111-16	1905 x 1152 x 497	1781 x 1028 x 320	989	643	4	2
D 111-17	1905 x 1152 x 580	1781 x 1028 x 403	1063	810	4	2
D 111-18	1905 x 1152 x 717	1781 x 1028 x 540	1187	1085	4	2
D 111-19	1905 x 1188 x 497	1781 x 1164 x 320	1006	663	4	2
D 111-20	1905 x 1288 x 580	1781 x 1164 x 403	1082	835	4	2
D 111-21	1905 x 1288 x 717	1781 x 1164 x 540	1207	1119	4	2

Burglar and fire-proof safes

Series HTFIII 320

Euro resistance grade VdS class III burglar protection according to EN 1143-1

Quality grade S 60 P Fire proof according to EN 1047-1

Construction

- Overall door thickness 137 mm
- All-round multi-walled corpus and door
- Trilateral bolt locking system and additional run-through rear grip section
- Armoured drill-safeguarded plating in lock area
- Fixture for floor anchorage

Basic configuration

- DIN right-hinged door
- Door opening angle of 180°
- Height adjustable compartment shelves (see table)
- Lacquered finish RAL 7035 light grey

Lock

- Double-bit security lock (incl. 2 keys)

Insurance cover

Resistance grade VdS III

€ 100,000.00** commercial

€ 200,000.00** private

**Fire protection
60 minutes**



HTFIII 320-04



Series HTFIII 320	Ext. dimensions H x W x D (in mm)	Interior dimensions H x W x D (in mm)	Weight (in kg)	Volume (in litres)	No. shelves	No. doors
HTFIII 320-01	776 x 591 x 660	530 x 363 x 295	631	57	2	1
HTFIII 320-02	936 x 591 x 660	690 x 363 x 295	770	74	2	1
HTFIII 320-03	1298 x 832 x 704	1052 x 604 x 340	1340	216	2	1
HTFIII 320-04	1483 x 832 x 704	1237 x 604 x 340	1477	254	3	1
HTFIII 320-05	1668 x 832 x 704	1422 x 604 x 340	1640	292	3	1

* The insurance sums specified are reference values only.

** The insurance sum will double if a VdS recognized burglar alarm system (BAS) is connected.

Burglar and fire-proof safes

Series HE 10

Security level B burglar protection to VDMA 24992 Stand 05/95

Quality grade S 120 P fire proof according to EN 1047-1

■ Construction

- Overall door thickness 134 mm
- All-round multi-walled corpus and door, with high-strength specialfilling
- All-round bolt locking system
- Fixture for floor anchorage

■ Basic configuration

- Single-door: DIN right-hinged door
- Double-door: DIN right / left-hinged door
- Door opening angle of 180°
- Height adjustable compartment shelves (see table)
- Lacquered finish RAL 7035 light grey

■ Lock

- Double-bit security lock (incl. 2 keys)

■ Insurance cover

Security level B according to VDMA 24992

€ 2,500.00* commercial up to 200 kg

Up to € 10,000.00* commercial from 300 kg

Up to € 40,000.00* private from 200 kg

**Fire protection
120 minutes**



HE 10-03

**Optional from model HE 10-08:
fire-resistant disc insert S 60 DIS**

Series HE 10	Ext. dimensions H x W x D (in mm)	Interior dimensions H x W x D (in mm)	Weight (in kg)	Volume (in litres)	No. shelves	No. doors
HE 10-01	489 x 605 x 560	271 x 460 x 331	168	41	1	1
HE 10-02	590 x 605 x 560	372 x 460 x 331	186	57	1	1
HE 10-03	1050 x 605 x 560	767 x 460 x 331	323	117	2	1
HE 10-04	1400 x 797 x 560	1107 x 649 x 331	483	238	2	1
HE 10-05	1600 x 797 x 560	1307 x 649 x 331	577	281	3	1
HE 10-06	1800 x 797 x 560	1507 x 649 x 331	708	324	3	1
HE 10-07	1800 x 1350 x 560	1502 x 1205 x 331	995	599	3	2
HE 10-08	1800 x 1766 x 560	1555 x 1621 x 331	1215	834	8	2
HE 10-09	2033 x 1766 x 560	1788 x 1621 x 331	1340	959	8	2

Burglar and fire-proof safes

Series HRS 46

Euro resistance grade VdS class I burglar protection according to EN 1143-1

Quality grade S 120 P fire proof according to EN 1047-1

Construction

- Door thickness 134 mm
- Multi-walled door and corpus
- All-round bolt locking system
- Fixture for floor anchorage

Basic configuration

- Single-door: DIN right-hinged door
- Double-door: DIN right / left-hinged door
- Door opening angle of 180°
- Height adjustable compartment shelves (see table)
- Lacquered finish RAL 7035 light grey

Lock

- Double-bit security lock (incl. 2 keys)

Insurance cover

Resistance grade VdS I

€ 20,000.00** commercial

€ 65,000.00** private

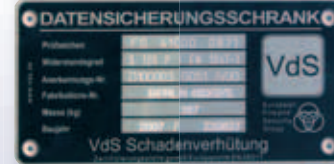
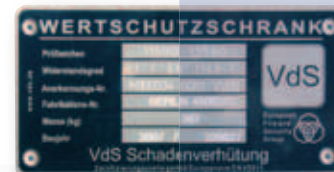

**Fire protection
120 minutes**

HRS 46006

Optional from model HRS 46004:
fire-resistant disc insert S 60 DIS

Series HRS 46	Ext. dimensions H x W x D (in mm)	Interior dimensions H x W x D (in mm)	Weight (in kg)	Volume (in litres)	No. shelves	No. doors
HRS 46000	489 x 605 x 560	271 x 460 x 331	178	41	1	1
HRS 46001	590 x 605 x 560	372 x 460 x 331	198	57	1	1
HRS 46002	1050 x 605 x 560	767 x 460 x 331	335	117	2	1
HRS 46003	1400 x 794 x 560	1107 x 649 x 331	497	238	2	1
HRS 46004	1600 x 794 x 560	1307 x 649 x 331	593	281	3	1
HRS 46005	1800 x 794 x 560	1507 x 649 x 331	728	324	3	1
HRS 46006	1800 x 1350 x 560	1502 x 1205 x 331	1025	599	3	2
HRS 46007	1800 x 1766 x 560	1555 x 1450 x 332	1310	834	8	2
HRS 46008	2033 x 1766 x 560	1788 x 1621 x 331	1460	959	8	2

* The insurance sums specified are reference values only.

** The insurance sum will double if a VdS recognized burglar alarm system (BAS) is connected.

Burglar and fire-proof safes

Series D 112

Euro resistance grade VdS class II burglar protection according to EN 1143-1

Quality grade S 120 P fire proof according to EN 1047-1

■ Construction

- Overall door thickness 138,5 mm
- Multi-walled door and corpus
- All-round bolt locking system
- Fixture for floor anchorage

■ Basic configuration

- Single-door: DIN right-hinged door
- Double-door: DIN right / left-hinged door
- Door opening angle of 180°
- Height adjustable compartment shelves (see table)
- Lacquered finish RAL 7035 light grey

■ Lock

- Double-bit security lock (incl. 2 keys)

■ Insurance cover

Resistance grade VdS II

bis € 50,000.00^{*/**} commercial

bis € 100,000.00^{*/**} private

**Fire protection
120 minutes**



D 112-06

**Optional from model D 112-05:
fire-resistant disc insert S 60 DIS**

Series D 112	Ext. dimensions H x W x D (in mm)	Interior dimensions H x W x D (in mm)	Weight (in kg)	Volume (in litres)	No. shelves	No. doors
D 112-01	550 x 632 x 573	315 x 460 x 331	240	48	1	1
D 112-02	600 x 632 x 573	365 x 460 x 331	264	56	1	1
D 112-03	1068 x 619 x 565	767 x 447 x 331	389	113	2	1
D 112-04	1418 x 821 x 573	1107 x 649 x 331	623	238	2	1
D 112-05	1618 x 821 x 573	1307 x 649 x 331	700	281	3	1
D 112-06	1811 x 821 x 573	1500 x 649 x 331	774	322	3	1
D 112-07	1821 x 1377 x 573	1505 x 1205 x 331	1139	600	3	2
D 112-08	1821 x 1775 x 573	1505 x 1603 x 331	1452	798	6	2
D 112-09	2042 x 1775 x 573	1770 x 1603 x 331	1605	939	8	2

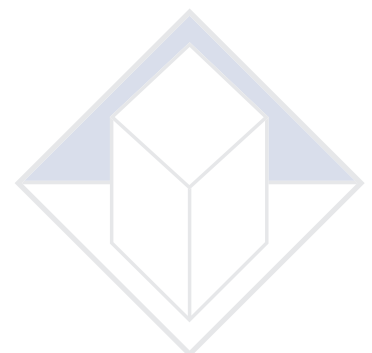

HARTMANN *Exclusive Line*

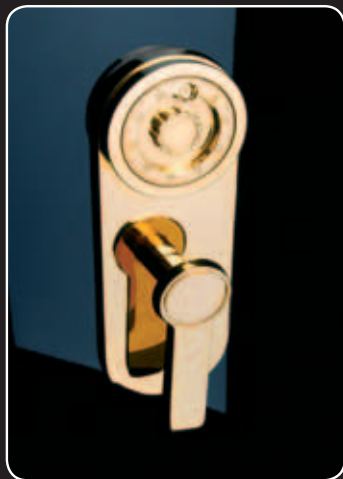

HARTMANN *Exclusive Line*

Give your safe an individual touch with a high-gloss finish or airbrushed lacquer and classy fittings. The interior can also be customized to suit your individual taste e.g. an interior trim, compartment shelves made out of a select type of wood, drawers lined with exclusive material and LED interior lighting.

You will find more inspiration and information about our *Exclusive Line* from page 72 or can simply contact one of our consultants for a personal consultation!



HARTMANN



TRESORE AG



HARTMANN *Filing cabinets*

Filing cabinets that are constructed like a safe offer the ideal compromise between simple steel filing cabinets and fire-proof safes for situations that require that files and documents need to be locked away securely.

Filing cabinets with a double-walled door and bolt locking system – even with a single-walled corpus – offer a great deal of security compared to steel filing cabinets.

All-through double-walled cabinets (i.e. door and corpus) also offer further protection from burglary and fire.

■ Single-walled filing cabinets

- SERIES HTF AP
- SERIES HTF MP
- SERIES HTF PP
- SERIES HTF SP

■ Double-walled fire-protected filing cabinets

- SERIES SD
- SERIES SDP Security level B

■ Fire-protected suspension file drawer cabinets

- SERIES HTH 220 Security level A
- SERIES HTH 230 Security level B



Single-walled filing cabinets

Series HTF AP

Construction

- Sealed door panel plating

Basic configuration

- 5-digit door opening counter
- Every cabinet comes with a serial number
- 1 fixed runner for suspension files
- Height adjustable compartment shelves with fixture for suspension files (see table)
- Log book keeping allows each procedure (entry/removal) to be tracked and traced
- Lacquered finish RAL 9006 white aluminium

Lock

- Tap-proof number combination lock (G5 series)
- Electronic lock with additional Double-bit lock (G6 series)

**Special safe for the
Military and Authorities**



5-digit door opening counter



HTF AP 900/G5

Series HTF AP	Ext. dimensions H x W x D (in mm)	Interior dimensions H x W x D (in mm)	Weight (in kg)	Volume (in litres)	No. shelves	No. doors
HTF AP 250/G5	1000 x 600 x 500	994 x 594 x 400	95	236	2	1
HTF AP 250/G6	1000 x 600 x 500	994 x 594 x 400	95	236	2	1
HTF AP 500/G5	1000 x 1200 x 500	994 x 1194 x 400	178	474	2	2
HTF AP 500/G6	1000 x 1200 x 500	994 x 1194 x 400	178	474	2	2
HTF AP 900/G5	1960 x 1000 x 500	1954 x 994 x 400	260	776	5	2
HTF AP 900/G6	1960 x 1000 x 500	1954 x 994 x 400	260	776	5	2

Single-walled filing cabinets

Series HTF MP 900/G2

Construction

- Multi media cabinet with doors constructed like safe doors
- All-round single-walled corpus

Basic configuration

- 1 pull-out compartment shelf for a keyboard
- Height adjustable compartment shelves can support loads of up to 100 kg (see table)
- Lacquered finish RAL 9006 white aluminium

Lock

- Double lock system: Double-bit lock and 4-button combination lock

MULTI MEDIA CABINET



HTF MP 900/G2

Model HTF MP	Ext. dimensions H x W x D (in mm)	Interior dimensions H x W x D (in mm)	Weight (in kg)	Volume (in litres)	No. shelves	No. doors
HTF MP 900/G2	1500 x 1000 x 690	1496 x 996 x 613	170	913	2	2

Single-walled filing cabinets

Series HTF PP 800/G1

■ Construction

- Filing cabinet with doors constructed like safe doors
- All-round single-walled corpus

■ Basic configuration

- 1 fixed runner for suspension files
- Height adjustable compartment shelves with fixture for suspension files (*see table*)
- Lacquered finish RAL 9006 white aluminium

■ Lock

- Double-bit lock



HTF PP 800/G1

Model HTF PP	Ext. dimensions H x W x D (in mm)	Interior dimensions H x W x D (in mm)	Weight (in kg)	Volume (in litres)	No. shelves	No. doors
HTF PP 800/G1	1980 x 1000 x 480	1975 x 995 x 400	170	830	5	2

Single-walled filing cabinets

Series HTF SP

■ Construction

- Filing cabinet with door/doors constructed like safe doors
- All-round single-walled corpus

■ Basic configuration

- 1 fixed runner for suspension files
- Height adjustable compartment shelves with fixture for suspension files (*see table*)
- Lacquered finish RAL 9006 white aluminium

■ Lock

- Double lock system: Double-bit lock and 4-button combination lock



HTF SP 900/G2

Series HTF SP	Ext. dimensions H x W x D (in mm)	Interior dimensions H x W x D (in mm)	Weight (in kg)	Volume (in litres)	No. shelves	No. doors
HTF SP 250/G2	1000 x 600 x 430	996 x 596 x 420	95	249	2	1
HTF SP 500/G2	1000 x 1200 x 500	994 x 1194 x 420	134	498	2	2
HTF SP 900/G2	1960 x 1000 x 500	1954 x 994 x 420	195	815	5	2

Double-walled fire-protected filing cabinets

Series SD

Construction

- All-round double-walled 30 mm corpus
- Exterior and interior shell: 1,5 mm steel
- Double-walled door: 80 mm
- High-quality fire-resistant insulation and all-round fire fold

Basic configuration

- Single-door: DIN right-hinged door
- Double-door: DIN right / left-hinged door
- Height adjustable compartment shelves (see table)
- Lacquered finish RAL 7035 light grey

Lock

- Double-bit security lock (incl. 2 keys)



SD 1996.2

Series SD	Ext. dimensions H x W x D (in mm)	Interior dimensions H x W x D (in mm)	Weight (in kg)	Volume (in litres)	No. shelves	No. doors
SD 876	800 x 700 x 560	740 x 640 x 395	95	179	1	1
SD 1275	1250 x 700 x 560	1190 x 630 x 375	125	281	3	1
SD 1576	1500 x 700 x 560	1410 x 630 x 375	145	333	4	1
SD 1975	1950 x 700 x 500	1890 x 630 x 375	180	447	4	1
SD 1996.1	1950 x 950 x 610	1890 x 880 x 425	230	609	4	1
SD 1996.2	1950 x 950 x 610	1890 x 880 x 425	250	609	4	2
SD 19126	1950 x 1260 x 610	1890 x 1190 x 425	390	956	4	2

Double-walled fire-protected filing cabinets

Series SDP

Security level B according to VDMA 24992 05/95

Construction

- All-round double-walled 60 mm corpus
- Double-walled door: 100 mm
- High-quality fire-resistant insulation and all-round fire fold

Basic configuration

- Single-door: DIN right-hinged door
- Double-door: DIN right / left-hinged door
- Door opening angle of 180°
- Lacquered finish RAL 7035 light grey

Lock

- Double-bit security lock (incl. 2 keys)

Insurance cover

Security level B according to VDMA 24992
 € 2,500.00* commercial up to 299 kg
 Up to € 10,000.00* commercial from 300 kg
 Up to € 40,000.00* private from 200 kg

Series SDP	Ext. dimensions H x W x D (in mm)	Interior dimensions H x W x D (in mm)	Weight (in kg)	Volume (in litres)	No. shelves	No. doors
SDP 875	800 x 700 x 500	675 x 565 x 335	205	127	1	1
SDP 1275	1250 x 700 x 500	1125 x 565 x 335	210	212	2	1
SDP 1575	1500 x 700 x 500	1375 x 565 x 335	220	260	3	1
SDP 1850	1850 x 950 x 550	1725 x 815 x 385	310	541	3	2
SDP 1975	1950 x 700 x 500	1825 x 565 x 335	345	345	4	1
SDP 1996	1950 x 950 x 550	1825 x 815 x 385	410	573	4	1
SDP 1996.2	1950 x 950 x 550	1825 x 815 x 385	415	573	4	2
SDP 19126	1950 x 1260 x 550	1825 x 1125 x 385	460	790	4	2



SDP 1996.2

* The insurance sums specified are reference values only.

Fire-protected suspension file drawer cabinets

Series HTH 220

Security level A according to VDMA 24992 05/95

Construction

- Single-walled 3 mm corpus
- Double-walled drawer doors 60 mm
- Drawers can be barred from two sides

Basic configuration

- Drawers on lightweight telescopic runners
- Lacquered finish RAL 7035 light grey

Lock

- Double-bit security lock on each drawer (incl. 2 keys per drawer)

Insurance cover

Security level A according to VDMA 24992
Up to € 2,500.00*

Series HTH 220	Ext. dimensions H x W x D (in mm)	Weight (in kg)	No. shelves
HTH 220-01	412 x 550 x 600	63	1
HTH 220-02	696 x 550 x 600	107	2
HTH 220-03	981 x 550 x 600	151	3
HTH 220-04	1266 x 550 x 600	196	4
HTH 220-05	1550 x 550 x 600	240	5



HTH 220-04

Double-walled fire-protected suspension file drawer cabinets

Series HTH 230

Security level B according to VDMA 24992 05/95

Construction

- All-round double-walled corpus 60 mm
- Fire-protection in corpus and drawer door
- Drawers can be barred from two sides

Basic configuration

- Drawers on lightweight telescopic runners
- Lacquered finish RAL 7035 light grey

Lock

- Double-bit security lock on each drawer (incl. 2 keys per drawer)

Insurance cover

Security level B according to VDMA 24992
€ 2,500.00* commercial up to 299 kg
Up to € 10,000.00* commercial from 300 kg
€ 40,000.00* private from 200 kg

Series HTH 230	Ext. dimensions H x W x D (in mm)	Weight (in kg)	No. shelves
HTH 230-01	412 x 550 x 600	200	1
HTH 230-02	696 x 550 x 600	200	2
HTH 230-03	981 x 550 x 600	300	3
HTH 230-04	1266 x 550 x 600	300	4
HTH 230-05	1550 x 550 x 600	300	5
HTH 230-06	1266 x 905 x 600	300	4 à 2

Suspension file doors



HTH 230-05



Detail of the Series HTH 230:
Storage of suspension files

Testing procedures for fire-proof and fire-protected safes

Fire-proofing and fire protection get test for in accordance with European standards. The most important standards are: EN 1047-1 (data security safes and disc inserts) and EN 15659 (light fire-proof cabinets).

Fire-proof safes according to EN 1047-1 – The “Braunschweig test”

Safes with fire-protection according to EN 1047-1 protect the contents from fire, smoke and extinguishing water for 60 or 120 minutes. The hardest of all fire tests is carried out at the Institute for Material Testing at the University of Technology in Braunschweig (MPA).

The test is split up into two parts: the fire resistance test and the fire burst and drop test. This test can last for up to 24 hours. Please read more about the procedure in detail on the opposite page.

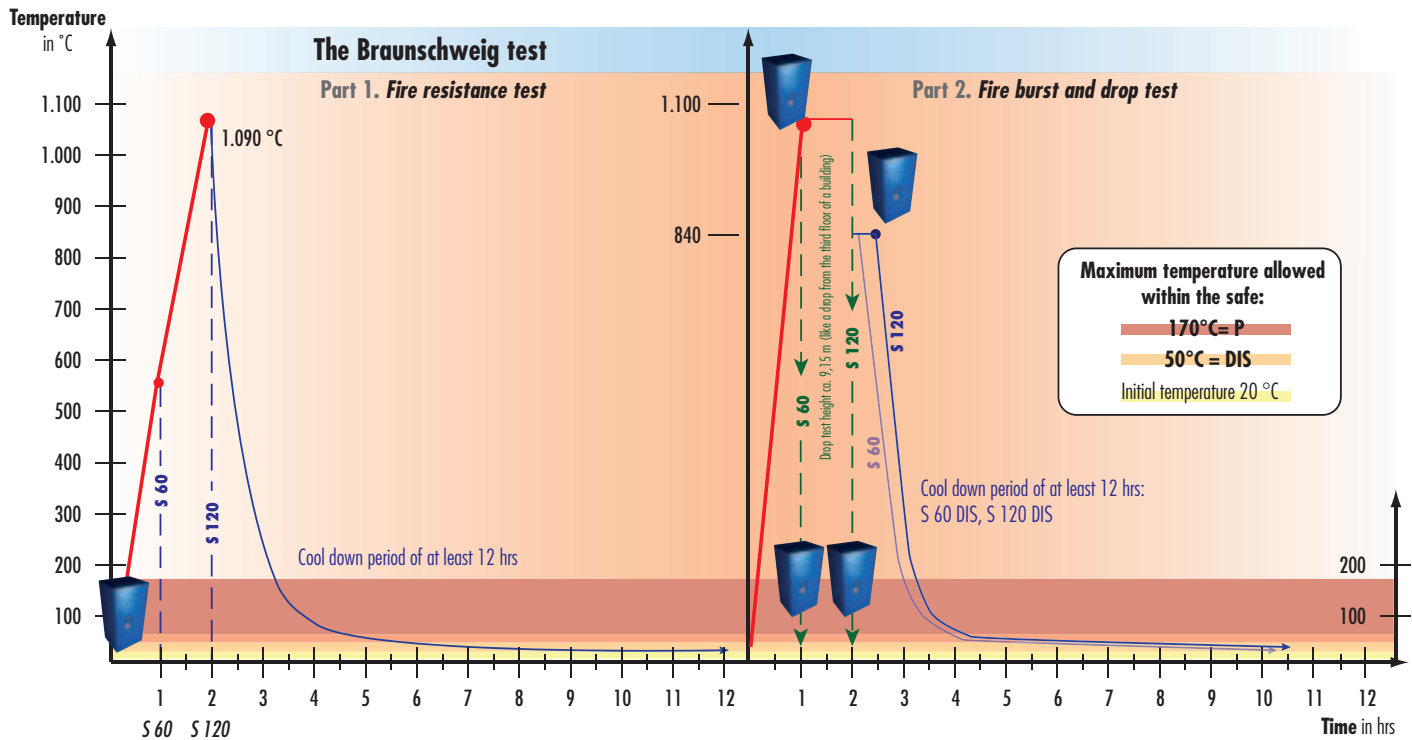

If a safe passes the test it receives one of the following fire-proof classes:

Quality grade	maximum temperature	maximum relative humidity
	within the safe during the test	
S 60 P	170°C	
S 120 P	170°C	
S 60 DIS	50°C	85 %
S 120 DIS	50°C	85 %

P = Suitable for heat sensitive paper documents with exposure limits of up to 170°C

DIS = Suitable for heat and humidity sensitive data carriers (discs) with exposure limits of up to 50°C and 85% humidity

Fire-protected safes according to EN 15659 (light fire-proof cabinets)

So-called “light fire-proof cabinets” protect documents and valuables from heat for an exposure time of 30 or 60 minutes (fire protection LFS 30 P and LFS 60P).

The requirements of both of these fire grades therefore lie under S 60 P according to EN 1047-1. In this test the safes also have to undergo a fire resistance test – in this case up to 840°C. Fire burst and drop test are not subsequently carried out however. The humidity does not get taken into consideration. The inside temperature of the safe is not allowed to exceed 172°C.

Due to the permitted inside temperatures, safes with a fire protection of LFS 30 P and LFS 60 P are not suited to store discs and other electronic data carriers.



For the fire resistance test the safe is heated up to a temperature of 1090°C for 60 or 120 minutes.



In the second part, the so-called fire burst and drop test, the safe is heated up to a temperature of about 1090 °C for a duration of 30 minutes.



The safe then gets dropped a distance of 9,15 meters from the ground onto a bed of gravel or crushed stone. This equates to a drop out of a three-storey building that is on fire.



Subsequently, the safe is again heated up to a temperature of 840 °C and is then left to cool down.



■ Data media safes

- Model **D 125-06** S 60 DIS
- SERIES **D 125** S 120 DIS

■ Vertical data media safes

- SERIES **HTFA 080** Security level A
- SERIES **HTFA 081** Security level A
- SERIES **HTFI 180** VdS class I/S 60 DIS
- SERIES **HTFI 181** VdS class I/S 60 DIS
- SERIES **HTFII 280** VdS class II/S 60 DIS
- SERIES **HTFIII 380** VdS class III/S 60 DIS

HARTMANN *Data media safes*

Our data media safes were successfully tested for fire resistance and underwent drop testing at the Institute for Material Testing at the University of Technology in Braunschweig (MPA).

During the whole test phase of up to 24 hours, the temperature of the inside of the safe is not allowed to increase by more than 30°C.

Thanks to special filling material and seals the data carriers housed in such cabinets can be ideally protected from fire, smoke and extinguishing water.



**2 safety standards in one –
optimal protection!**



Data media safes

Model D 125-06

Quality grade S 60 DIS fire proof according to EN 1047-1

Construction

- Door thickness 175 mm
- Corpus thickness 135 mm
- Fire-resistant insulation of the safe body
- Door and corpus filled with a high-quality fire-resistant insulation
- Quadrilateral all-round fire fold

Basic configuration

- DIN right-hinged door
- Panic lock
(door will lock automatically when closed)
- Door opening angle of 180°
- Lacquered finish RAL 7035 light grey
- Interior fitting components in RAL 7015 slate grey











Lock

- Double-bit security lock (incl. 2 keys)



D 125-06

Data capacity per safe

Series D 125	MB 3480/ 3490 110 x 125 x 25 in mm	Mini Streamer Tape 89 x 66 x 20 in mm	Streamer Tape 162 x 107 x 25 in mm	DLT Tape 112 x 112 x 32 in mm	Giga Tape 4 81 x 60 x 16 in mm	Giga Tape 8 102 x 68 x 20 in mm	Microfilm tape 100 x 100 x 25 in mm	Optical Disc 3 1/2" 94 x 90 x 6 in mm	3 1/2" discs 94 x 190 x 3 in mm	CD-ROM 142 x 124 x 10 in mm	Ext. dimensions H x W x D (in mm) Ext. depth + hinge	Interior dimensions H x W x D (in mm)	Weight (in kg)
													
D 125-01	128	352	84	84	625	304	192	416	1200	240	732 x 786 x 918	332 x 444 x 470	288
D 125-01/2	128	352	84	84	625	304	192	416	1200	240	732 x 786 x 918	332 x 444 x 470	320
D 125-02	256	704	210	210	1250	608	320	1200	2000	480	1052 x 786 x 918	652 x 444 x 470	380
D 125-02/2	256	704	210	210	1250	608	320	1200	2000	480	1052 x 786 x 918	652 x 444 x 470	460
D 125-03	384	968	294	294	1750	836	512	1920	3200	720	1295 x 786 x 918	895 x 444 x 470	455
D 125-03/2	384	968	294	294	1750	836	512	1920	3200	720	1295 x 786 x 918	895 x 444 x 470	543
D 125-04	640	1584	504	462	2750	1368	768	3120	5200	1200	1850 x 786 x 918	1450 x 444 x 470	631
D 125-04/2	640	1584	504	462	2750	1368	768	3120	5200	1200	1850 x 786 x 918	1450 x 444 x 470	785
D 125-05	1280	3204	1140	1078	5500	2880	1536	6240	10400	2400	1850 x 1195x 918	1450 x 855 x 470	922
D 125-05/2	1280	3204	1140	1078	5500	2880	1536	6240	10400	2400	1850 x 1195x 918	1450 x 855 x 470	1150
D 125-06	66	192	63	75	365	160	105	444	720	132	712 x 560 x 770	390 x 290 x 460	221

* The insurance sums specified are reference values only.

** The insurance sum will double if a VdS recognized burglar alarm system (BAS) is connected.

Data media safes
 Series D 125-01 bis D 125-05

Data media safes
 Series D 125-01/2 bis D 125-05/2

Quality grade S 120 DIS
fire proof according to EN 1047-1
Construction

- Door thickness 277 mm
- Corpus thickness 171 mm
- Resistant and reinforced insulation material combination
- Quadrilateral all-round fire fold

Basic configuration

- DIN right-hinged door
- Panic lock
(door will lock automatically when closed)
- Lacquered finish RAL 7035 light grey
- Interior fitting components in RAL 7015 slate grey

Lock

- Double-bit security lock (incl. 2 keys)

Euro resistance grade VdS class II according to EN 1143-1
Quality grade S 120 DIS *fire proof according to EN 1047-1*
Construction

- Door thickness 277 mm
- Corpus thickness 171 mm
- A combination of insulation materials offers maximum resistance
- Quadrilateral all-round fire fold

Basic configuration

- DIN right-hinged door
- Panic lock
(door will lock automatically when closed)
- Lacquered finish RAL 7035 light grey
- Interior fitting components in RAL 7015 slate grey

Lock

- Double-bit security lock (incl. 2 keys)

Insurance cover

Resistance grade VdS II

 € 50,000.00^{*/**} commercial

 € 100,000.00^{*/**} private

Fire protection
120 minutes

	Volume (in liters)	Grade
	71	S 120 DIS
	71	S 120 DIS
	139	S 120 DIS
	139	S 120 DIS
	191	S 120 DIS
	191	S 120 DIS
	310	S 120 DIS
	310	S 120 DIS
	590	S 120 DIS
	590	S 120 DIS
	52	S 60 DIS



D 125-04

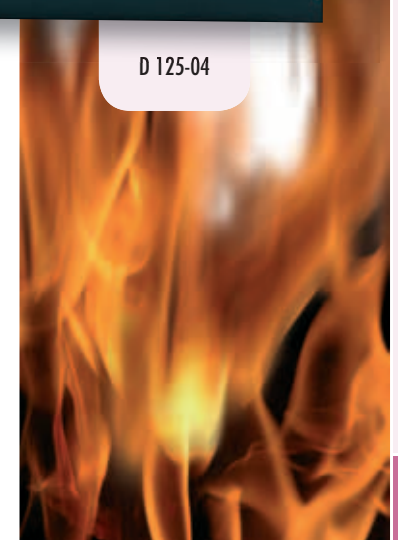

Vertical data media safes

Series HTFA 080 and series HTFA 081

Security level A according to VDMA 24992 05/95

Quality grade S 60 DIS fire proof according to EN 1047-1

■ Construction

- Door thickness 95 mm
- Multi-walled door and corpus
- All-round bolt locking system
- High-quality fire-resistant insulation of the safe body
- Door and corpus filled with high-quality fire-resistant insulation
- Pedestal height 85 mm

■ Basic configuration

- Vertical pullout door (*Series HTFA 080*)
- DIN right-hinged door (*Series HTFA 081*)
- Drawers (*see table*)
- 1 shelf (*Series HTFA 081*)
- 2 drill holes for floor anchorage
- Lacquered finish RAL 7035 light grey

■ Lock

- Double-bit security lock (incl. 2 keys)

**Fire protection
60 minutes**



HTFA 080-02

Optional: vertical pullout door or DIN right-hinged door

Vertical data media safes

Series HTFI 180 and series HTFI 181

Euro resistance grade VdS class I burglar protection according to EN 1143-1

Quality grade S 60 DIS fire proof according to EN 1047-1

■ Construction

- Door thickness 95 mm
- Multi-walled door and corpus
- All-round bolt locking system
- High-quality fire-resistant insulation of the safe body
- Door and corpus filled with high-quality fire-resistant insulation
- Pedestal height 85 mm

■ Basic configuration

- Vertical pullout door (*Series HTFI 180*)
- DIN right-hinged door (*Series HTFI 181*)
- Drawers (*see table*)
- 1 shelf (*Series HTFI 181*)
- 2 drill holes for floor anchorage
- Lacquered finish RAL 7035 light grey

■ Lock

- Double-bit security lock (incl. 2 keys)

■ Insurance cover

Resistance grade VdS I
 € 20,000.00*** commercial
 € 65,000.00*** private

**Fire protection
60 minutes**



HTFI 181-01

HTFI 180-02

* The insurance sums specified are reference values only.

** The insurance sum will double if a VdS recognized burglar alarm system (BAS) is connected.

Vertical data media safes

Series HTFII 280

Euro resistance grade VdS class II burglar protection according to EN 1143-1

Quality grade S 60 DIS fire proof according to EN 1047-1

■ Construction

- Door thickness 114 mm
- Multi-walled door and corpus
- Door opening angle of 180°
- Trilateral bolt locking system for the door
- Run-through rear grip section on the hinge side
- High-quality fire-resistant insulation of the safe body
- Door and corpus filled with high-quality fire-resistant insulation
- Pedestal height 85 mm

■ Basic configuration

- Vertical pullout door
- DIN right-hinged door
- Drawers (see table)
- 2 drill holes for floor anchorage
- Lacquered finish RAL 7035 light grey

■ Lock

- Double-bit security lock (incl. 2 keys)

■ Insurance cover

- Resistance grade VdS II
- € 50,000.00^{**/**} commercial
- € 100,000.00^{**/**} private



**Fire protection
60 minutes**

HTFII 280-04

Data media safes

Vertical data media safes

Series HTFIII 380

Euro resistance grade VdS class III burglar protection according to EN 1143-1

Quality grade S 60 DIS fire proof according to EN 1047-1

■ Construction

- Door thickness 137 mm
- Multi-walled door and corpus
- Door opening angle of 180°
- Trilateral bolt locking system for the door
- Run-through rear grip section on the hinge side
- High-quality fire-resistant insulation of the safe body
- Door and corpus filled with high-quality fire-resistant insulation

■ Basic configuration

- Vertical pullout door
- DIN right-hinged door
- Drawers (see table)
- 2 drill holes for floor anchorage
- Lacquered finish RAL 7035 light grey

■ Lock

- Double-bit security lock (incl. 2 keys)

■ Insurance cover

- Resistance grade VdS III
- € 100,000.00^{**/**} commercial
- € 200,000.00^{**/**} private











**Fire protection
60 minutes**

HTFIII 380-05

Vertical data media safes

Series HTFA 080 to series HTFIII 380

Series HTF	Data capacity per safe									Compartment about safe (folder high)	Exterior dimensions (H x W x D) in mm Ext. depth + hinge	Interior dimensions (H x W x D) in mm	Weight (in kg)	Volume (in litres)
	Streamer Tape 162 x 107 x 25 in mm 	DLT-tape 112 x 112 x 32 in mm 	Giga Tape 4 81 x 60 x 16 in mm 	Giga Tape 8 102 x 60 x 20 in mm 	Microfilm tape 100 x 100 x 25 in mm 	Optical Disc 3 1/2" 94 x 90 x 6 in mm 	Discs 3 1/2" 94 x 190 x 3 in mm 	CD-ROM 142 x 124 x 10 in mm 	Drawers Height 75 mm 					
Series HTFA 080 - Security level A according to VDMA 24992 05/95 - fire proof according to EN 1047-1 S 60 DIS with vertical pullout door														
HTFA 080-01	78	87	378	187	105	513	1188	198	3	-	635 x 560 x 620	400 x 380 x 387	201	58
HTFA 080-02	104	116	504	238	140	684	1485	264	3	-	635 x 560 x 755	400 x 380 x 522	222	79
HTFA 080-03	156	174	756	374	210	1026	2376	396	2x3	-	1270 x 560 x 620	400 x 380 x 387	402	116
HTFA 080-04	208	232	1008	476	280	1368	2970	528	2x3	-	1270 x 560 x 755	400 x 380 x 522	444	158
Series HTFA 081 - Security level A according to VDMA 24992 05/95 - fire proof according to EN 1047-1 S 60 DIS with DIN right-hinged door														
HTFA 081-01	78	87	378	187	105	513	1188	198	-	-	635 x 560 x 620	400 x 380 x 387	201	58
HTFA 081-02	104	116	504	238	140	684	1485	264	-	-	635 x 560 x 755	400 x 380 x 522	222	79
Series HTFI 180 - Security level VdS I resistance grade I to VdS standard EN 1143-1 - Quality grade S 60 DIS - EN 1047-1 with vertical pullout door														
HTFI 180-01	78	87	378	187	105	513	1188	198	3	-	635 x 560 x 620	400 x 380 x 387	200	58
HTFI 180-02	104	116	504	238	140	684	1485	264	3	-	635 x 560 x 755	400 x 380 x 522	226	79
HTFI 180-03	156	174	756	374	210	1026	2376	396	2x3	-	1270 x 560 x 620	400 x 380 x 387	400	116
HTFI 180-04	208	232	1008	476	280	1368	2970	528	2x3	-	1270 x 560 x 755	400 x 380 x 522	452	158
Series HTFI 181 - Security level VdS I resistance grade I to VdS standard EN 1143-1 - Quality grade S 60 DIS - EN 1047-1 with DIN right-hinged door														
HTFI 181-01	78	87	378	187	105	513	1188	198	-	-	635 x 560 x 620	400 x 380 x 387	200	58
HTFI 181-02	104	116	504	238	140	684	1485	264	-	-	635 x 560 x 755	400 x 380 x 522	236	79
Series HTFII 280 - Security level VdS II resistance grade II to VdS standard EN 1143-1 - Quality grade S 60 DIS - EN 1047-1														
HTFII 280-01	78	87	378	187	105	513	1188	198	3	-	779 x 684 x 815	400 x 380 x 387	740	58
HTFII 280-02	104	116	504	238	140	684	1485	264	3	-	779 x 684 x 950	400 x 380 x 522	815	79
HTFII 280-03	78	87	378	187	105	513	1188	198	3	1	1079 x 684 x 815	400 x 380 x 387	880	58
HTFII 280-04	104	116	504	238	140	684	1485	264	3	1	1079 x 684 x 950	400 x 380 x 522	950	79
HTFII 280-05	156	174	756	374	210	1026	2376	396	2x3	-	1414 x 684 x 815	(2x) 400 x 380 x 387	1220	116
HTFII 280-06	208	232	1008	476	280	1368	2970	528	2x3	-	1414 x 684 x 950	(2x) 400 x 380 x 522	1290	158
HTFII 280-07	156	174	756	374	210	1026	2376	396	2x3	1	1714 x 684 x 815	(2x) 400 x 380 x 387	1315	116
HTFII 280-08	208	232	1008	476	280	1368	2970	528	2x3	1	1714 x 684 x 950	(2x) 400 x 380 x 522	1395	158
Series HTFIII 380 - Security level VdS III resistance grade III to VdS standard EN 1143-1 - Quality grade S 60 DIS - EN 1047-1														
HTFIII 380-01	78	87	378	187	105	513	1188	198	3	-	795 x 700 x 853	400 x 380 x 387	820	58
HTFIII 380-02	104	116	504	238	140	684	1485	264	3	-	795 x 700 x 988	400 x 380 x 522	895	79
HTFIII 380-03	78	87	378	187	105	513	1188	198	3	1	1095 x 700 x 853	400 x 380 x 387	990	58
HTFIII 380-04	104	116	504	238	140	684	1485	264	3	1	1095 x 700 x 988	400 x 380 x 522	1085	79
HTFIII 380-05	156	174	756	374	210	1026	2376	396	2x3	-	1430 x 700 x 853	(2x) 400 x 380 x 387	1220	116
HTFIII 380-06	208	232	1008	476	280	1368	2970	528	2x3	-	1430 x 700 x 988	(2x) 400 x 380 x 522	1335	158
HTFIII 380-07	156	174	756	374	210	1026	2376	396	2x3	1	1730 x 700 x 853	(2x) 400 x 380 x 387	1450	116
HTFIII 380-08	208	232	1008	476	280	1368	2970	528	2x3	1	1730 x 700 x 988	(2x) 400 x 380 x 522	1580	158

HARTMANN
TRESORE



HARTMANN *Furniture safes*

The compact security solution for at home or in the office:
subtly and unobtrusively integrable.

All models are ready for mounting onto the wall or floor or
into an existing piece of furniture.

■ Furniture safes

- SERIES HPKT 300 Security level A
- SERIES HPKT 400 Security level B

■ Burglar-proof furniture safes

- SERIES F 103 VdS class I

■ Burglar and fire-proof furniture safes

- SERIES HPKTF 300 Security level A + S1
Fire protection LFS 30 P
- SERIES HPKTF 400 Security level B + S2
Fire protection LFS 30 P



Furniture safes
Series HPKT 300
Security level A according to VDMA 24992 05/95

Construction

- Double-walled door 40 mm
- All-round single-walled corpus
- Drill holes for floor anchorage

Lock

- Double-bit security lock (incl. 2 keys)

Basic configuration

- DIN right-hinged door
- Lacquered finish RAL 9005 black



HPKT 300-02

Series HPKT 300	Ext. dimensions H x W x D (in mm)	Interior dimensions H x W x D (in mm)	Weight (in kg)	Volume (in litres)	No. shelves
HPKT 300-01	220 x 350 x 250	214 x 344 x 210	15	16	-
HPKT 300-02	400 x 400 x 350	394 x 394 x 275	32	43	1

Furniture safes
Series HPKT 400
Security level B according to VDMA 24992 05/95

Construction

- Double-walled door 40 mm
- All-round double-walled corpus 30 mm
- Drill-proof armoured plating in lock area
- Bolt locking system
- Drill holes for floor anchorage

Lock

- Double-bit security lock (incl. 2 keys)

Insurance cover

 Security level B according to VDMA 24992
 Up to € 2,500.00* private and commercial

Basic configuration

- DIN right-hinged door
- Lacquered finish RAL 7035 light grey



HPKT 400-03

Series HPKT 400	Ext. dimensions H x W x D (in mm)	Interior dimensions H x W x D (in mm)	Weight (in kg)	Volume (in litres)	No. shelves
HPKT 400-01	450 x 285 x 378	380 x 205 x 290	30	23	1
HPKT 400-02	285 x 450 x 378	205 x 380 x 290	32	23	1
HPKT 400-03	610 x 430 x 395	546 x 366 x 300	66	56	1
HPKT 400-04	810 x 430 x 395	730 x 355 x 295	80	76	2
HPKT 400-07	950 x 430 x 395	870 x 355 x 295	82	91	2
HPKT 400-08	1150 x 430 x 395	1070 x 355 x 295	92	112	2

* The insurance sums specified are reference values only.

** The insurance sum will double if a VdS recognized burglar alarm system (BAS) is connected.

Burglar-proof furniture safes

Series F 103

Resistance grade Euro VdS class I according to EN 1143-1

■ Construction

- Extra strong construction
- Door thickness 90 mm
- Door panel 12 mm
- All-round multi-walled corpus
- Multilateral bolt locking system
- High-quality fire-resistant insulation
- Fixture for floor anchorage

■ Basic configuration

- DIN right-hinged door
- Adjustable compartment shelves
- Door opening angle of 90°
- Lacquered finish RAL 7035 light grey

■ Lock

- Double-bit security lock (incl. 2 keys)

■ Insurance cover

Resistance grade VdS I

€ 20,000.00^{*/**} commercial

€ 65,000.00^{*/**} private



F 103-06

Series F 103 ^{***}	Ext. dimensions H x W x D (in mm)	Interior dimensions H x W x D (in mm)	Weight (in kg)	Volume (in litres)	No. shelves
F 103-01	340 x 400 x 250	230 x 316 x 122	62	9	1
F 103-02	340 x 500 x 300	230 x 416 x 172	82	17	1
F 103-03	340 x 500 x 410	230 x 416 x 295	95	28	1
F 103-04	440 x 500 x 410	330 x 416 x 295	120	41	1
F 103-05	540 x 500 x 410	430 x 416 x 295	130	53	1
F 103-06	640 x 500 x 410	530 x 416 x 295	148	65	2
F 103-07	740 x 500 x 410	630 x 416 x 295	168	77	2
F 103-08	840 x 500 x 410	730 x 416 x 295	184	90	2
F 103-09	1040 x 500 x 410	930 x 416 x 295	215	114	2
F 103-10	1040 x 500 x 500	930 x 416 x 372	242	144	2
F 103-11	1240 x 500 x 410	1130 x 416 x 295	248	139	2
F 103-12	1240 x 500 x 500	1130 x 416 x 372	274	175	2
F 103-13	740 x 740 x 560	630 x 656 x 432	250	179	2
F 103-14	840 x 740 x 560	630 x 656 x 432	265	179	2
F 103-15	1040 x 740 x 560	930 x 656 x 432	325	264	2
F 103-16	1240 x 740 x 560	1130 x 656 x 432	377	320	2
F 103-17	1540 x 740 x 560	1430 x 656 x 432	450	405	3
F 103-18	1840 x 740 x 560	1730 x 656 x 432	545	490	3
F 103-19	1840 x 1200 x 560	1730 x 1146 x 432	730	857	2

*** To receive the insurance category stated above, some of the models in this series can be loaded with a weight of under 200 or 300 kg respectively.

Burglar and fire-proof furniture safes

Series HPKTF 300

Security level A according to VDMA 24992 05/95 and **S 1** according to EN 14450

Quality grade LFS 30 P fire safety according EN 15659

Construction

- Double-walled door
- Double-walled corpus
- Fixture for floor anchorage
- Door opening angle of 180°

Basic configuration

- DIN right-hinged door
- Lacquered finish RAL 7035 light grey

Lock

- High security double-bit lock (incl. 2 keys)

Insurance cover

Security level S1 according to EN 14450

Up to € 5,000.00* private

Up to € 2,500.00* commercial



HPKTF 300-02

Series HPKTF 300	Ext. dimensions H x W x D (in mm)	Interior dimensions H x W x D (in mm)	Weight (in kg)	Volume (in litres)	No. shelves
HPKTF 300-01	370 x 490 x 455	229 x 355 x 293	40	24	1
HPKTF 300-02	470 x 380 x 455	329 x 245 x 293	39	24	1
HPKTF 300-03	470 x 490 x 455	329 x 355 x 293	46	34	1
HPKTF 300-04	670 x 490 x 455	529 x 355 x 293	61	55	1
HPKTF 300-05	820 x 490 x 455	679 x 355 x 293	69	71	1

Burglar and fire-proof furniture safes

Series HPKTF 400

Security level B according to VDMA 24992 05/95 and **S 2** according to EN 14450

Quality grade LFS 30 P fire safety according EN 15659

Construction

- Double-walled door
- Double-walled corpus
- Fixture for floor anchorage
- Door opening angle of 180°

Basic configuration

- DIN right-hinged door
- Lacquered finish RAL 7035 light grey

Lock

- High security double-bit lock (incl. 2 keys)

Insurance cover

Security level S2 according to EN 14450

Up to € 20,000.00* private

Up to € 2,500.00* commercial



HPKTF 400-04

Series HPKTF 400	Ext. dimensions H x W x D (in mm)	Interior dimensions H x W x D (in mm)	Weight (in kg)	Volume (in litres)	No. shelves
HPKTF 400-01	375 x 495 x 472	229 x 355 x 293	69	24	1
HPKTF 400-02	475 x 385 x 472	329 x 245 x 293	68	25	1
HPKTF 400-03	475 x 495 x 472	329 x 355 x 293	79	34	1
HPKTF 400-04	675 x 495 x 472	529 x 355 x 293	100	55	1
HPKTF 400-05	825 x 495 x 472	679 x 355 x 293	115	71	1

* The insurance sums specified are reference values only.



HARTMANN *Wall and floor safes*

These space-saving solutions can be discretely built into a wall or floor. Unauthorized persons or burglars will not be able to locate or break into a safe if they do not know about the existence or whereabouts of a safe – not to mention time consuming for them.

If thought of well in advance and as a preventative measure against burglary, wall and floor safes offer a sound alternative when building new buildings or modifying existing ones.

■ Wall safes

- SERIES MS 100 Security level B
- SERIES S 101 VdS class I

■ Floor safes

- SERIES HTS 132
- SERIES HTS 133 Security level B

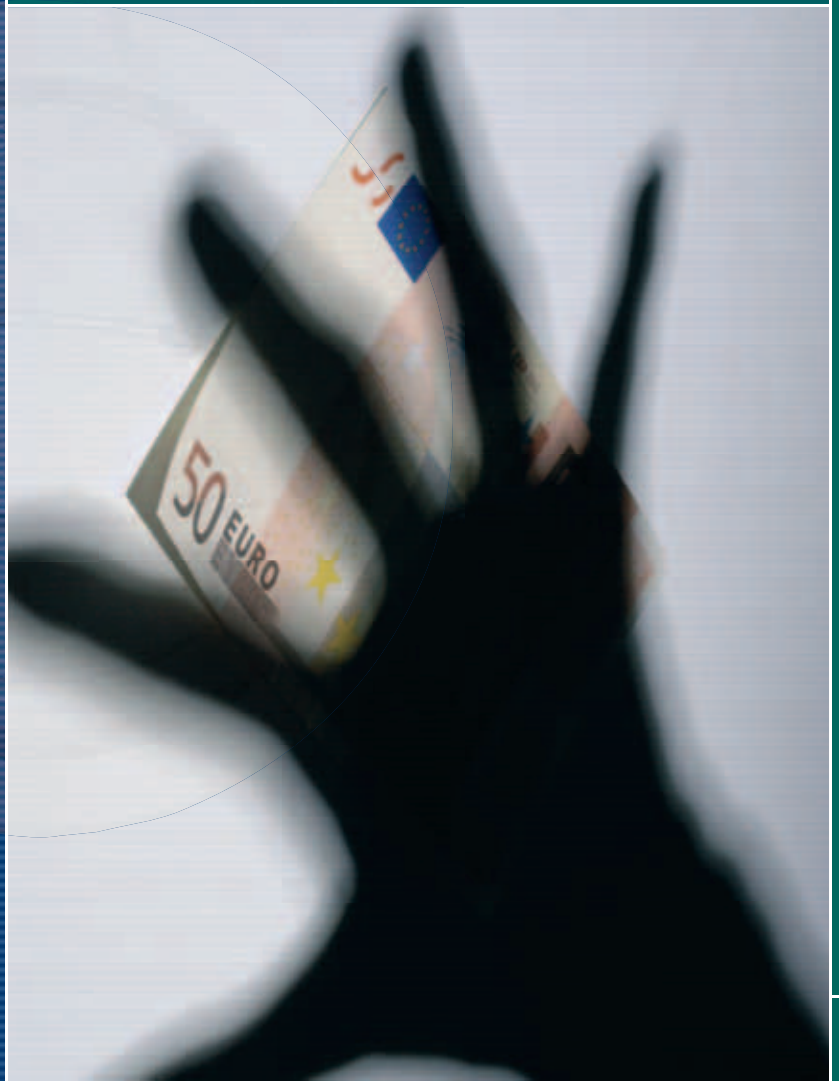

Wall safes

Series MS 100

Security level B according to VDMA 24992 05/95

■ Construction

- Double-walled door 40 mm
- All-round single-walled corpus
- Fire fold, fire-resistant insulation according to DIN 4102
- Bolt locking system

■ Basic configuration

- DIN right-hinged door
- Lacquered finish RAL 7035 light grey

■ Lock

- Double-bit security lock (incl. 2 keys)

■ Insurance cover

Security level B according to VDMA 24992

€ 10,000.00* commercial

€ 40,000.00* private



MS 100-04



MS 100-07



MS 100-05

Series MS 100	Ext. dimensions H x W x D (in mm)	Interior dimensions H x W x D (in mm)	Weight (in kg)	Volume (in litres)
MS 100-01	166 x 300 x 200	106 x 240 x 155	8	4
MS 100-02	266 x 300 x 200	206 x 240 x 135	12	8
MS 100-03	426 x 420 x 200	366 x 360 x 138	22	18
MS 100-04	330 x 465 x 370	264 x 399 x 320	30	34
MS 100-05	426 x 420 x 360	366 x 360 x 310	26	41
MS 100-06	600 x 420 x 360	540 x 360 x 310	45	60
MS 100-07	800 x 420 x 360	740 x 360 x 310	55	83

* The insurance sums specified are reference values only.

** The insurance sum will double if a VdS recognized burglar alarm system (BAS) is connected.

Wall safes
Series S 101
Euro resistance grade VdS class I according to EN 1143-1
Construction

- Extra strong construction
- Door thickness of 85 mm
- Door plating 12 mm
- Sandwiched multi-walled construction
- Multilateral bolt locking system with 35 mm diameter bolts
- Especially high-quality fire-resistant insulation

Basic configuration

- DIN right-hinged door
- Height adjustable compartment shelves (see table)
- Door opening angle of 90°
- Lacquered finish RAL 7035 light grey

Lock

- Double-bit security lock (incl. 2 keys)

Insurance cover

Resistance grade VdS I

 € 20,000.00^{*/**} commercial

 € 65,000.00^{*/**} private

S 101-01



S 101-11

**Example installation
of the S 101-16**

Series S 101	Ext. dimensions H x W x D (in mm)	Interior dimensions H x W x D (in mm)	Weight (in kg)	Volume (in litres)	No. shelves
S 101-01	330 x 390 x 210	230 x 307 x 118	34	8	1
S 101-02	330 x 390 x 260	230 x 307 x 168	36	12	1
S 101-03	330 x 490 x 210	230 x 407 x 118	42	11	1
S 101-04	330 x 490 x 260	230 x 407 x 168	44	16	1
S 101-05	330 x 490 x 380	230 x 407 x 290	50	27	1
S 101-06	430 x 490 x 210	330 x 407 x 118	55	16	1
S 101-07	430 x 490 x 260	330 x 407 x 168	57	23	1
S 101-08	430 x 490 x 380	330 x 407 x 290	60	39	1
S 101-09	530 x 490 x 210	430 x 407 x 118	63	21	1
S 101-10	530 x 490 x 260	430 x 407 x 168	65	29	1
S 101-11	530 x 490 x 380	430 x 407 x 290	68	51	1
S 101-12	630 x 490 x 270	530 x 412 x 171	70	36	2
S 101-13	630 x 490 x 300	530 x 407 x 208	73	45	2
S 101-14	630 x 490 x 380	530 x 407 x 290	79	63	2
S 101-15	730 x 490 x 300	630 x 407 x 208	82	53	2
S 101-16	730 x 490 x 387	645 x 424 x 292	89	74	2
S 101-17	830 x 490 x 300	730 x 407 x 208	92	62	2
S 101-18	830 x 490 x 380	730 x 407 x 290	100	86	2
S 101-19	1030 x 490 x 380	930 x 407 x 290	112	110	2
S 101-20	1030 x 490 x 500	930 x 407 x 408	123	154	2
S 101-21	1230 x 490 x 380	1130 x 407 x 290	128	133	2
S 101-22	1230 x 490 x 500	1130 x 407 x 408	138	188	2
S 101-23	700 x 700 x 500	600 x 617 x 408	140	151	2
S 101-24	800 x 700 x 500	700 x 617 x 408	149	176	2
S 101-25	1000 x 700 x 500	900 x 617 x 408	170	227	2
S 101-26	1200 x 700 x 500	1100 x 617 x 408	180	277	2
S 101-27	1500 x 700 x 500	1400 x 617 x 408	202	352	3
S 101-28	1800 x 700 x 500	1700 x 617 x 408	227	428	3

Floor safes

Series HTS 132

■ Functionality

- Floor safes are especially suited for hidden installation. An important key, cash reserve or other valuables can be stored very discreetly in a hidden place. Floor safes also offer protection from fire.

■ Construction

- Suited for installation as a floor or wall safe

■ Basic configuration

- Lacquered finish RAL 7035 light grey

■ Lock

- Half cylinder profile lock (incl. 3 keys)

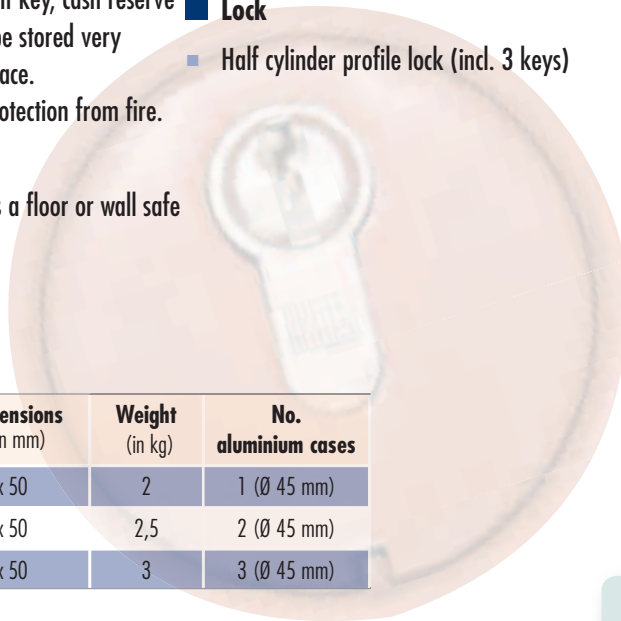

HTS 132-01



HTS 132-02

Series HTS 132	Ext. dimensions h x Ø (in mm)	Weight (in kg)	No. aluminium cases
HTS 132-01	150 x 50	2	1 (Ø 45 mm)
HTS 132-02	225 x 50	2,5	2 (Ø 45 mm)
HTS 132-03	320 x 50	3	3 (Ø 45 mm)

Floor safes

Series HTS 133

Security level B according to VDMA 24992 05/95

■ Construction

- Double-walled door 80 mm
- Door panel thickness of 12 mm
- Door with gas-filled shock absorber
- Lockable deposit lug

■ Lock

- Double-bit security lock (incl. 2 keys)

■ Insurance cover

Security level B according to VDMA 24992
Up to € 2,500.00* private and commercial

■ Basic configuration

- Lacquered finish RAL 7035 light grey



HTS 133-01



Series HTS 133	Ext. dimensions H x W x D (in mm)	Interior dimensions H x W x D (in mm)	Door passage dimensions h x w (in mm)	Weight (in kg)	Volume (in litres)
HTS 133-01	540 x 440 x 330	335 x 410 x 310	220 x 280	35	48
HTS 133-02	540 x 490 x 330	335 x 460 x 310	220 x 280	40	48

**Sturdy construction
for floor installation**

* The insurance sums specified are reference values only.



■ Key cabinets – key boxes

- SERIES HS 511
- SERIES HTS 100
- SERIES HTS 104
- SERIES HTS 105
- SERIES HTS 107
- SERIES HTS 108
- SERIES HTS 110
- SERIES HTS 122

■ Key safes

- SERIES HPST 120 Solid construction
- SERIES HTS 117 Solid construction
- SERIES HTS 118 Solid construction
- SERIES HTS 113 Security level A
- SERIES HTS 114 Security level A
- SERIES HTS 115 Security level A
- SERIES HTS 111 Security level B
- SERIES HTS 112 Security level B
- SERIES HTS 119 Security level B
- SERIES HTS 120 Security level B
- SERIES HTS 116 Security level S1
- SERIES HTS 121 VdS class I

■ "Last"-key containers

- SERIES HTS 101

■ Key control /key management system

- SERIES HTS 320

HARTMANN *Key Safes*

HARTMANN key safes offer customised and perfect key management solutions. They are available in different security levels and with different equipment and furnishing options.

Our experience shows that this topic is an important issue in nearly every company or with nearly every authoritative body etc. Often it is not just about safe key storage but also about management and organisation. With the combination of security measures and electronic locking systems, key administration and management can be organised reliably and without high personnel costs.

In our specialist catalogue, we offer sector-specific solutions to the automobile industry (car dealerships and car rental services) to best serve the necessary requirements.



Key boxes

Series HS 511

■ Construction

- Single-walled wing doors
- All-round single-walled corpus
- Flat front thanks to enclosed doors with all-round border

■ Basic configuration

- Swing key index
- Adjustable hook rack, different colours, consecutively numbered
- Lacquered finish RAL 7035 light grey

■ Lock

- Cylinder lock (incl. 2 keys)

Series HS 511	Ext. dimensions H x W x D (in mm)	Weight (in kg)	No. hooks
HS 511-064	450 x 300 x 80	4	65
HS 511-100	550 x 380 x 80	6	100
HS 511-200	550 x 730 x 80	18	200
HS 511-400	550 x 730 x 140	27	400
HS 511-500	550 x 730 x 205	29	500



HS 511-100

Emergency key boxes

Series HTS 100

■ Construction

- Steel plating with replaceable glass pane

■ Basic configuration

- DIN right-hinged door
- Lacquered finish RAL 3001 red

■ Lock

- Cylinder lock (incl. 2 keys)

Preparation for profile half cylinder and wall installation frame possible at a surcharge



HTS 100-05

Series HTS 100	Ext. dimensions H x W x D (in mm)	Weight (in kg)	No. hooks	Toggle	Fixture to seal
HTS 100-01	150 x 120 x 32	0,5	1	-	-
HTS 100-02	150 x 120 x 32	0,6	1	✓	-
HTS 100-03	150 x 120 x 32	0,6	1	✓	✓
HTS 100-04	200 x 200 x 50	1	3	-	-
HTS 100-05	200 x 200 x 50	1	3	✓	-
HTS 100-06	200 x 200 x 50	1	3	✓	✓

Key cabinets

Series HTS 104

■ Construction

- Single-walled door
- All-round single-walled corpus
- Fixture for mounting to a wall

■ Basic configuration

- DIN right-hinged door
- Adjustable hook rack, different colours, consecutively numbered
- Lacquered finish RAL 7035 light grey

■ Lock

- Cylinder lock (incl. 2 keys)

Series HTS 104	Ext. dimensions H x W x D (in mm)	Weight (in kg)	No. hooks
HTS 104-01	255 x 190 x 80	2	10
HTS 104-02	255 x 190 x 80	3	20
HTS 104-03	255 x 190 x 130	2	20
HTS 104-04	305 x 230 x 80	3	25
HTS 104-05	305 x 230 x 80	3	30
HTS 104-06	305 x 230 x 80	3	35
HTS 104-07	305 x 240 x 130	5	42
HTS 104-08	305 x 240 x 130	5	49
HTS 104-09	305 x 240 x 130	6	84



HTS 104-09

Key cabinets

Series HTS 105

■ Construction

- Single-walled door
- Single-walled wing doors
- Fixture for mounting to a wall

■ Basic configuration

- DIN right-hinged door
- Adjustable hook rack, different colours, consecutively numbered
- Lacquered finish RAL 7035 light grey

■ Lock

- Cylinder lock (incl. 2 keys)

Series HTS 105	Ext. dimensions H x W x D (in mm)	Weight (in kg)	No. hooks
HTS 105-01	350 x 270 x 80	3	21
HTS 105-02	350 x 270 x 80	4	42
HTS 105-03	450 x 300 x 80	4	32
HTS 105-04	450 x 300 x 80	6	64
HTS 105-05	550 x 380 x 80	6	50
HTS 105-06	550 x 380 x 80	9	100

Optional:
preparation for
installation of a profile half
cylinder lock for integration
into existing locking
systems



HTS 105-06

Key cabinets

Series HTS 107 - double doors

Construction

- Single-walled wing doors
- All-round single-walled corpus
- Flat front thanks to enclosed doors with all-round border
- Fixture for mounting to a wall

Basic configuration

- Individually adjustable key racks
- Lacquered finish RAL 7035 light grey
- Adjustable hook rack, different colours, consecutively numbered

Lock

- Cylinder lock (incl. 2 keys)

Series HTS 107	Ext. dimensions H x W x D (in mm)	Weight (in kg)	No. hooks
HTS 107-01	550 x 730 x 80	15	100
HTS 107-02	550 x 730 x 80	18	200
HTS 107-03	550 x 730 x 140	24	300
HTS 107-04	550 x 730 x 140	27	400
HTS 107-05	550 x 730 x 205	34	500
HTS 107-06	550 x 730 x 205	37	600
HTS 107-07	1300 x 730 x 250	46	780
HTS 107-08	1300 x 730 x 250	47	860
HTS 107-09	1300 x 730 x 250	47	940
HTS 107-10	1300 x 730 x 250	48	1020
HTS 107-11	1300 x 730 x 250	49	1170



HTS 107-07

Key cabinets

Series HTS 108

Construction

- Single-walled door
- All-round single-walled corpus
- Flat front thanks to enclosed doors with all-round border
- Fixture for mounting to a wall

Basic configuration

- Individually adjustable key racks
- Lacquered finish RAL 7035 light grey
- DIN right-hinged door 2 doors, DIN right and DIN left

Lock

- Cylinder lock (incl. 2 keys)

With individually adjustable hook system!

Series HTS 108	Ext. dimensions H x W x D (in mm)	Weight (in kg)	No. hook fixtures	Partition wall
HTS 108-01	255 x 190 x 130	7	20	-
HTS 108-02	305 x 240 x 130	9	30	-
HTS 108-03	350 x 270 x 130	12	40	-
HTS 108-04	450 x 300 x 130	15	60	-
HTS 108-05	550 x 380 x 130	18	90	-
HTS 108-06	550 x 380 x 205	25	180	✓ 1x
HTS 108-07	550 x 730 x 130	35	190	-
HTS 108-08	550 x 730 x 250	45	350	✓ 2x
HTS 108-09	1300 x 730 x 250	65	700	✓ 2x

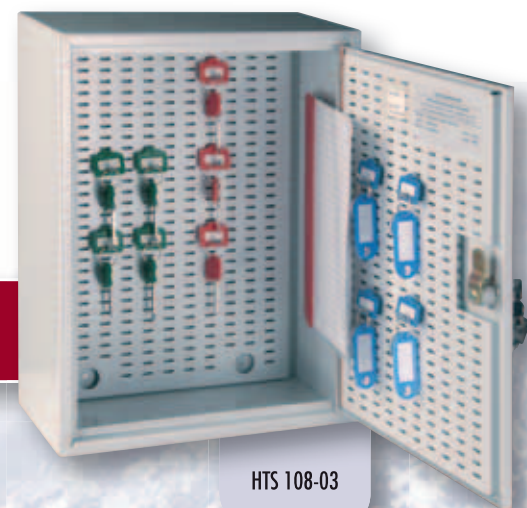

HTS 108-03

Key cabinets

Series HTS 110

■ Construction

- Single-walled door
- All-round single-walled corpus
- Flat front thanks to enclosed doors with all-round border
- Fixture for mounting to a wall or cupboard/unit

■ Basic configuration

- Individually adjustable key racks
- Rust-free stainless steel
- DIN right-hinged door

■ Lock

- Cylinder lock (incl. 2 keys)

Series HTS 110	Ext. dimensions H x W x D (in mm)	Weight (in kg)	No. hook fixtures
HTS 110-01	350 x 270 x 130	6	40
HTS 110-02	450 x 300 x 130	8	60
HTS 110-03	550 x 380 x 130	10	90
HTS 110-04	550 x 380 x 210	20	180

The individually adjustable hook system allows for the storage of longer and larger bunches of keys – the hooks can be adjusted vertically and horizontally.



Optional:
side deposit chute
for keys!

HTS 110-03

Key cabinets

Series HTS 122

■ Construction

- Single-walled door
- All-round single-walled corpus
- Flat front thanks to enclosed doors with all-round border
- Fixture for mounting to a wall or cupboard/unit

■ Basic configuration

- DIN right-hinged door
- Individually adjustable key racks
- Rust-free stainless steel

■ Lock

- Cylinder lock (incl. 2 keys)

Optional:
preparation for installation
of a profile half cylinder lock
for integration into existing
locking systems

**Stainless steel and rust free
for special requirements!**

Series HTS 122	Ext. dimensions H x W x D (in mm)	Weight (in kg)	No. hooks
HTS 122-01	350 x 270 x 130	5	42
HTS 122-02	450 x 300 x 130	7	64
HTS 122-03	550 x 380 x 130	9	100
HTS 122-04	550 x 380 x 210	17	200



HTS 122-03

Key safes – solid construction

Series HPST 120

Construction

- Double-walled door
- Drill-proof door plating in lock area
- Bolt locking system
- Fixture for mounting to a wall

Basic configuration

- Key deposit shaft (top left)
- DIN right-hinged door
- Individually adjustable key racks, different colours, consecutively numbered
- Lacquered finish RAL 7035 light grey

Lock

- Double-bit security lock (incl. 2 keys)



HPST 120-60

Series HPST 120	Ext. dimensions H x W x D (in mm)	Weight (in kg)	No. hooks
HPST 120-10	300 x 375 x 105	12	10
HPST 120-30	400 x 375 x 105	15	30
HPST 120-60	400 x 375 x 120	16	60
HPST 120-100	640 x 460 x 120	27	100

Key safes – solid construction

Series HTS 117

Construction

- Single-walled door 3 mm
- All-round single-walled corpus 1,5 mm
- Fixture for mounting to a wall

Basic configuration

- DIN right-hinged door
- Individually adjustable key racks, different colours, consecutively numbered
- Rust-free stainless steel

Lock

- Double-bit security lock (incl. 2 keys)



HTS 117-02

Series HTS 117	Ext. dimensions H x W x D (in mm)	Weight (in kg)	No. hooks
HTS 117-01	350 x 350 x 200	15	60
HTS 117-02	550 x 500 x 200	18	100
HTS 117-03	800 x 500 x 200	24	160
HTS 117-04	1000 x 600 x 200	50	400
HTS 117-05	1200 x 600 x 200	70	480
HTS 117-06	1500 x 600 x 200	85	600

Key safes – solid construction

Series HTS 118

■ Construction

- Single-walled door 3 mm
- All-round single-walled corpus 1,5 mm
- Fixture for mounting to a wall

■ Basic configuration

- DIN right-hinged door
- Individually adjustable key hooks
- Rust-free stainless steel

■ Lock

- Double-bit security lock (incl. 2 keys)

Series HTS 118	Ext. dimensions H x W x D (in mm)	Weight (in kg)	No. hooks
HTS 118-01	350 x 350 x 200	20	50
HTS 118-02	550 x 500 x 200	30	100
HTS 118-03	800 x 500 x 200	40	150
HTS 118-04	1000 x 600 x 200	55	250
HTS 118-05	1200 x 600 x 200	70	350
HTS 118-06	1500 x 600 x 200	85	450



HTS 118-03

**All models also available
with electronic lock!**

Key safes

Series HTS 113

Security level A according to *VDMA 24992 05/95*

■ Construction

- Double-walled door
- All-round single-walled corpus
- Fixture for mounting to a wall

■ Basic configuration

- DIN right-hinged door
- Individually adjustable key racks, different colours, consecutively numbered
- Lacquered finish RAL 7035 light grey

■ Lock

- Double-bit security lock (incl. 2 keys)

■ Insurance cover

Security level A according to *VDMA 24992*

Up to € 2,500.00*

Series HTS 113	Ext. dimensions H x W x D (in mm)	Weight (in kg)	No. hooks
HTS 113-01	235 x 245 x 175	10	25
HTS 113-02	305 x 245 x 175	14	30
HTS 113-03	405 x 245 x 175	19	40



HTS 113-03

* If professionally mounted/installed according to the user manual. The insurance sums specified are reference values only.

Key safes

Series HTS 114

Security level A according to VDMA 24992 05/95

Construction

- Double-walled door 50 mm
- All-round single-walled corpus 3 mm
- Trilateral locking system
- Fixture for mounting to a wall

Lock

- Double-bit security lock (incl. 2 keys)

Basic configuration

- DIN right-hinged door – 2 doors, DIN right and DIN left
- Individually adjustable key racks, different colours, consecutively numbered
- Lacquered finish RAL 7035 light grey

Insurance cover

Security level A according to VDMA 24992
Up to € 2,500.00*

Series HTS 114	Ext. dimensions H x W x D (in mm)	Weight (in kg)	No. hooks	No. doors
HTS 114-01	436 x 460 x 120	22	70	1
HTS 114-02	636 x 460 x 120	34	100	1
HTS 114-03	636 x 460 x 200	36	150	1
HTS 114-04	636 x 460 x 200	37	200	1
HTS 114-05	636 x 460 x 300	42	300	1
HTS 114-06	636 x 812 x 200	95	400	2
HTS 114-07	636 x 812 x 300	110	600	2



HTS 114-02

Key safes

Series HTS 115

Security level A according to VDMA 24992 05/95

Construction

- Double-walled door 50 mm
- Door panel thickness of 6 mm
- Single-walled wing doors 3 mm
- Fixture for mounting to a wall

Lock

- Double-bit security lock (incl. 2 keys)

Basic configuration

- DIN right-hinged door – 2 doors, DIN right and DIN left
- Back wall, door and side walls with new vertically and horizontally adjustable
- Lacquered finish RAL 7035 light grey

Insurance cover

Security level A according to VDMA 24992
Up to € 2,500.00*

Series HTS 115	Ext. dimensions H x W x D (in mm)	Weight (in kg)	No. hook fixtures	No. doors
HTS 115-01	350 x 350 x 200	20	50	1
HTS 115-02	550 x 500 x 200	30	150	1
HTS 115-03	800 x 500 x 200	40	200	1
HTS 115-04	1000 x 600 x 200	55	300	1
HTS 115-05	1200 x 600 x 200	70	350	1
HTS 115-06	1500 x 600 x 200	85	450	1
HTS 115-07	1000 x 1000 x 200	100	550	2
HTS 115-08	1500 x 1000 x 200	150	800	2
HTS 115-09	1800 x 1000 x 200	195	1000	2



HTS 115-06

Wall key safes

Series HTS 111

Security level B according to VDMA 24992 05/95

Construction

- Double-walled door
- All-round single-walled corpus

Basic configuration

- DIN right-hinged door
- Individually adjustable key racks, different colours, consecutively numbered
- Lacquered finish RAL 7035 light grey

Lock

- Double-bit security lock (incl. 2 keys)

Insurance cover

Security level B according to VDMA 24992

€ 10,000.00* commercial

€ 40,000.00* private

Series HTS 111	Ext. dimensions H x W x D (in mm)	Weight (in kg)	No. hooks
HTS 111-01	230 x 240 x 110	9	20
HTS 111-02	300 x 240 x 110	11	25
HTS 111-03	400 x 240 x 110	15	35



HTS 111-03

Wall key safes

Series HTS 112

Security level B according to VDMA 24992 05/95

Construction

- Double-walled door
- All-round single-walled corpus
- All-round fire insulation

Basic configuration

- DIN right-hinged door
- Individually adjustable key racks, different colours, consecutively numbered
- Lacquered finish RAL 7035 light grey

Lock

- Double-bit security lock (incl. 2 keys)

Insurance cover

Security level B according to VDMA 24992

€ 10,000.00* commercial

€ 40,000.00* private

Series HTS 112	Ext. dimensions H x W x D (in mm)	Weight (in kg)	No. hooks
HTS 112-01	420 x 420 x 200	22	70
HTS 112-02	600 x 420 x 200	30	100
HTS 112-03	800 x 420 x 200	40	160



HTS 112-03

*If professionally mounted/installed according to the user manual. The insurance sums specified are reference values only.

Key safes

Series HTS 119

Security level B according to VDMA 24992 05/95

Construction

- Double-walled door 60 mm
- All-round double-walled corpus 60 mm
- All-round fire fold
- Fixture for mounting to a wall

Lock

- Double-bit security lock (incl. 2 keys)

Basic configuration

- DIN right-hinged door
- Individually adjustable key racks, different colours, consecutively numbered
- Lacquered finish RAL 7035 light grey

Insurance cover

Security level B according to VDMA 24992

Up to € 2,500.00* private und commercial

Series HTS 119	Ext. dimensions H x W x D (in mm)	Weight (in kg)	No. hooks
HTS 119-01	450 x 520 x 250	36	70
HTS 119-02	606 x 520 x 250	54	100
HTS 119-03	806 x 520 x 250	72	150
HTS 119-04	1200 x 670 x 300	105	300
HTS 119-05	1500 x 670 x 300	130	420
HTS 119-06	1800 x 670 x 300	152	510



HTS 119-02

Key safes

Series HTS 120

Security level B according to VDMA 24992 05/95

Construction

- Double-walled door 80 mm
- All-round double-walled corpus
- All-round fire fold
- Full pullout partition walls on telescopic runners

Basic configuration

- DIN right-hinged door
- Individually adjustable key racks, different colours
- Lacquered finish RAL 7035 light grey

Lock

- Double-bit security lock (incl. 2 keys)

Insurance cover

Security level B according to VDMA 24992

€ 2,500.00* private 200 kg

€ 10,000.00* commercial 300 kg

€ 40,000.00* private 300 kg

Series HTS 120	Ext. dimensions H x W x D (in mm)	Weight (in kg)	No. hooks	No. partition walls
HTS 120-01	600 x 500 x 500	200	320	4
HTS 120-02	800 x 500 x 500	200	400	4
HTS 120-03	600 x 636 x 500	300	600	6
HTS 120-04	800 x 636 x 500	300	980	7
HTS 120-05	1000 x 636 x 500	300	1400	7
HTS 120-06	1200 x 636 x 500	300	1540	7
HTS 120-07	1200 x 636 x 500	300	1960	7
HTS 120-08	1500 x 806 x 500	350	2560	8
HTS 120-09	1500 x 806 x 500	350	2880	8
HTS 120-10	1500 x 806 x 500	350	3200	10
HTS 120-11	1500 x 806 x 500	350	3600	10
HTS 120-12	1800 x 806 x 500	450	4000	10
HTS 120-13	600 x 636 x 500	300	400	4



HTS 120-07

Key safes

Series HTS 116

Security level S 1 according to VdS 2862 EN 14450

- **Construction**
 - Double-walled door 65 mm
 - Door leaf 6 mm
 - All-round single-walled corpus 3 mm
 - All-round fire fold
 - Trilateral locking device
 - Fixture for mounting to a wall
- **Basic configuration**
 - DIN right-hinged door – 2 doors, DIN right and DIN left
 - Individually adjustable key hooks
 - Lacquered finish RAL 7035 light grey
- **Lock**
 - Double-bit security lock (incl. 2 keys)

- **Insurance cover**
 - Security level S1 according to EN 14450
 - Up to € 5,000.00* private
 - Up to € 2,500.00* commercial

Series HTS 116	Ext. dimensions H x W x D (in mm)	Weight (in kg)	No. hook fixtures	No. doors
HTS 116-01	350 x 350 x 200	18	50	1
HTS 116-02	550 x 500 x 200	32	150	1
HTS 116-03	800 x 500 x 200	42	200	1
HTS 116-04	1000 x 600 x 200	57	300	1
HTS 116-05	1200 x 600 x 200	72	350	1
HTS 116-06	1500 x 600 x 200	105	450	1
HTS 116-07	1000 x 1000 x 200	102	550	2
HTS 116-08	1500 x 1000 x 200	152	800	2
HTS 116-09	1800 x 1000 x 200	197	1000	2



HTS 116-04

Key safes

Key safes

Series HTS 121

Euro resistance grade VdS class I according to EN 1143-1

- **Construction**
 - Multi-walled door 90 mm
 - Solid door leaf 12 mm
 - All-round multi-walled corpus
 - Quadrilateral locking device
 - Fixture for floor anchorage
 - Full pullout partition walls on telescopic runners
- **Basic configuration**
 - DIN right-hinged door
 - Individually adjustable key racks, different colours
 - Lacquered finish RAL 7035 light grey

- **Lock**
 - Double-bit security lock (incl. 2 keys)
- **Insurance cover**
 - Resistance grade VdS I
 - € 20,000.00** commercial
 - € 65,000.00** private

Also available in VdS class II Series HTS 221 and VdS class III Series HTS 321

Series HTS 121	Ext. dimensions H x W x D (in mm)	Weight (in kg)	No. hooks	No. partition walls	No. doors
HTS 121-01	636 x 496 x 500	170	300	5	1
HTS 121-02	836 x 496 x 500	200	400	5	1
HTS 121-03	1036 x 496 x 500	260	600	5	1
HTS 121-04	736 x 736 x 500	260	880	8	1
HTS 121-05	836 x 736 x 500	275	1080	8	1
HTS 121-06	1036 x 736 x 500	325	1500	8	1
HTS 121-07	1236 x 736 x 500	390	2060	8	1
HTS 121-08	1536 x 736 x 500	475	2980	9	1
HTS 121-09	1536 x 736 x 500	490	3300	9	1
HTS 121-10	1836 x 736 x 500	630	3800	9	1
HTS 121-11	1836 x 1200 x 500	800	5000	13	2



HTS 121-05

** The insurance sums specified are reference values only.

** The insurance sum will double if a VdS recognized burglar alarm system (BAS) is connected.

„Last“-Key containers

Series HTS 101

Construction

- Door 3 mm
- Corpus 3 mm
- Rust-free stainless steel suitable for outside
- Additional cover flap with seal around the lock
- HTS 101-02 comes with a frame for mounting to a wall

Basic configuration

- DIN right-hinged door
- Rust-free stainless steel

Lock

- Standard: HARTMANN Professional 2 electronic lock with electronic review option (no key) programmable to 1 master code and 99 user codes. Last 4,050 entries can be read via a PC.



HTS 101-01



HTS 101-02

Stainless steel key safe to wall in or fix with screws: ideal for the "last" key

Series HTS 101	Ext. dimensions H x W x D (in mm)	Weight (in kg)	No. hooks
HTS 101-01	170 x 240 x 100	5	10
HTS 101-02	196 x 266 x 100	6	10

Key control and key management system

Series HTS 320

Functionality

1. The keys get tagged to a numbered key tag using a disposable ring



2. Keys can only get removed from the key board using a coloured access key.



3. The coloured access key remains in the key board upon key removal and thus shows who has the key.

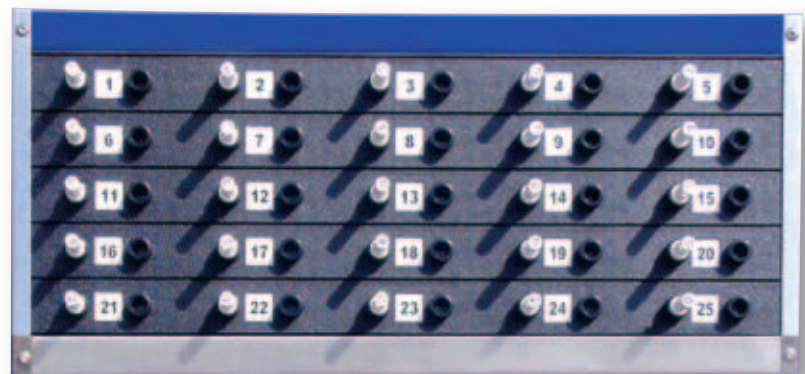

HTS 320-04

Series HTS 320	Ext. dimensions H x W x D (in mm)	No. key pins	No. central keys	No. tamper-proof key tags	Weight (in kg)
HTS 320-01	101 x 545 x 110	5	1	15	1,40
HTS 320-04	260 x 545 x 110	25	5	35	3,65
HTS 320-05	440 x 545 x 110	50	10	75	5,50
HTS 320-06	821 x 545 x 110	100	20	150	11,50



HARTMANN *Deposit and drop-down safes*

These safes are characterised by their drawers and deposit shafts that have been technically developed to protect against burglary or unauthorised access. Depending on their equipment, they are also known as drawer safes or night safes.

These systems allow cash or valuables (e.g. cash strongboxes, envelopes, waiter/tress purses etc.) to be deposited without having to open the safe. They are often used to safely store cash in the gastronomy trade, tanning salons, petrol stations and other branches of business. While employees may be able to deposit items, only authorised personnel (e.g. managers) will be able to open the safe.

■ Deposit and drop-down safes

- **SERIES HS 510** in line with security level Security level A
- **SERIES SP** in line with security level Security level B
- **SERIES HTDPB** in line with security level Security level B
- **SERIES HTDPI** Resistance grade D-I/EN 1143-2
- **SERIES HTDPII** Resistance grade D-II/EN 1143-2
- **SERIES HTDPIII** Resistance grade D-III/EN 1143-2
- **SERIES HPDI** Resistance grade D-I/EN 1143-2
- **SERIES HPDII** Resistance grade D-II/EN 1143-2
- **SERIES HPDIV** Resistance grade D-IV/EN 1143-2
- **SERIES HTDTI** Resistance grade D-I/EN 1143-2
- **SERIES HTDTII** Resistance grade D-II/EN 1143-2
- **SERIES HTDTIII** Resistance grade D-III/EN 1143-2



Drop-down safes

Series HS 510

In line with **Security level A** burglar protection according to VDMA 24992 05/95

■ Construction

- Double-walled door
- Door thickness of 45 mm
- Fixture for floor or wall anchorage

■ Basic configuration

- Door opening angle of 90 °
- Lacquered finish RAL 7035 light grey

■ Lock

- Main door: double-bit security lock (incl. 2 keys)

■ HS 510-01

- The HS 510-01 model comes with a side flap deposit shaft for cash strongboxes

■ HS 510-03

- The HS 510-03 comes with a front flap deposit shaft for cash strongboxes



HS 510-01



HS 510-04



HS 510-03

Series HS 510	Ext. dimensions H x W x D (in mm)	Interior dimensions H x W x D (in mm)	Weight (in kg)	Volume (in litres)
HS 510-01	300 x 465 x 290	290 x 405 x 245	25	29
HS 510-03	600 x 250 x 250	380 x 244 x 184	27	17
HS 510-04	600 x 460 x 460	380 x 454 x 394	55	68

Drop-down safes

Series SP and Series HTDPB 100

In line with **Security level B** burglar protection according to VDMA 24992 05/95

Construction

- Double-walled door 80 mm, door leaf 6 mm (series HTDPB: 12 mm)
- All-round multi-walled corpus
- Door and corpus with high-quality fire-resistant insulation according to DIN 4102
- All-round fire fold
- Drill-proof armoured plating in lock area
- Multiple bolt locking system
- Fixture for floor anchorage

Basic configuration

- DIN right-hinged door
- Height adjustable compartment shelves (see table)
- Lacquered finish RAL 7035 light grey

Lock

- Double-bit security lock (incl. 2 keys)

Installation e.g. SP 700



SP 1465



Drawers with deposit shaft for aluminium cases and insert for banknotes and € coins

HTDPB 100-02

Ideal for underneath counters!



SP 765

Series SP	Ext. dimensions H x W x D (in mm)	Interior dimensions H x W x D (in mm)	Weight (in kg)	Volume (in litres)	Collection tray height (in mm)	No. shelves
SP 700	700 x 640 x 530	330 x 475 x 360	300	56	-	1
SP 765	750 x 640 x 530	490 x 520 x 350	300	89	-	1
SP 1065	1030 x 670 x 500	730 x 550 x 380	300	153	300	1
SP 1265	1230 x 670 x 500	930 x 550 x 380	300	194	300	2
SP 1465	1430 x 670 x 500	1130 x 550 x 380	300	236	300	2
Series HTDPB 100	Ext. dimensions H x W x D (in mm)	Interior dimensions H x W x D (in mm)	Weight (in kg)	Volume (in litres)	Collection tray height (in mm)	No. shelves
HTDPB 100-01	620 x 500 x 410	330 x 400 x 295	85	39	-	-
HTDPB 100-02	820 x 500 x 410	530 x 400 x 295	105	63	-	1
HTDPB 100-03	1020 x 500 x 410	730 x 400 x 295	132	86	-	1

Drawer safes

Series HTDPI

Resistance grade D-I according to PN-EN 1143-2

Construction

- Door thickness of 105 mm
- All-round multi-walled corpus
- Multi-walled armoured drawer
- Drawer (200 mm) on light running telescopic runners incl. retraction block

Basic configuration

- DIN right-hinged door
- Lacquered finish RAL 7035 light grey

Lock

- Double-bit security lock on the door and on the drawer



HTDPI 1

Series HTDPI	Ext. dimensions H x W x D (in mm)	Interior dimensions H x W x D (in mm)	Weight (in kg)	Volume (in litres)
HTDPI 1	800 x 650 x 550	530 x 520 x 370	300	102
HTDPI 2	1000 x 650 x 550	730 x 520 x 370	300	140
HTDPI 3	1200 x 650 x 550	930 x 520 x 370	300	179
HTDPI 4	1400 x 650 x 550	1130 x 520 x 370	300	217

Drawer safes

Series HTDPII

Resistance grade D-II according to PN-EN 1143-2

Construction

- Door thickness of 114 mm
- All-round multi-walled corpus with special concrete filling
- Multi-walled armoured drawer
- Drawer (200 mm) on light running telescopic runners incl. retraction block
- Activation of an emergency lock if broken into

Basic configuration

- DIN right-hinged door
- Lacquered finish RAL 7035 light grey

Lock

- Double-bit security lock on the door and on the drawer



HTDPII 1

Series HTDPII	Ext. dimensions H x W x D (in mm)	Interior dimensions H x W x D (in mm)	Weight (in kg)	Volume (in litres)
HTDPII 1	800 x 650 x 550	530 x 520 x 370	385	102
HTDPII 2	1000 x 650 x 550	730 x 520 x 370	470	140
HTDPII 3	1200 x 650 x 550	930 x 520 x 370	560	179
HTDPII 4	1400 x 650 x 550	1130 x 520 x 370	630	217

Drawer safes

Series HTDP III

Resistance grade D-III according to PN-EN 1143-2

■ Construction

- Multi-walled door 137 mm
- All-round multi-walled corpus with high-strength concrete filling
- Multi-walled armoured drawer
- Drawer (200 mm) on light running telescopic runners incl. retraction block
- Drawer front filled with special concrete filling
- Activation of an emergency lock if broken into
- Prepared for installation of recognized burglar alarm system components ready for connection to a burglar alarm system (BAS)

■ Basic configuration

- DIN right-hinged door
- Lacquered finish RAL 7035 light grey

■ Lock

- Double-bit security lock on the door and on the drawer



HTDP III 3



Series HTDP III	Ext. dimensions H x W x D (in mm)	Interior dimensions H x W x D (in mm)	Weight (in kg)	Volume (in litres)
HTDP III 1	800 x 650 x 550	500 x 500 x 330	470	83
HTDP III 2	1000 x 650 x 550	700 x 500 x 330	565	116
HTDP III 3	1200 x 650 x 550	900 x 500 x 330	675	149
HTDP III 4	1400 x 650 x 550	1100 x 500 x 330	770	182



Drawer safes

Series HPDI

Euro resistance grade VdS class D-I according to EN 1143-2 (VdS 2528)

Construction

- Trilateral door construction 145 mm
- All-round multi-walled corpus with special filling
- Trilateral bolt locking system
- Bolt diameter Ø 40 mm
- Lock and locking system area equipped with additional punch proof plating
- Fixture for floor anchorage incl. approved fixing material

Basic configuration

- DIN right-hinged door
- Door opening angle of 180°
- Lacquered finish RAL 7035 light grey

Lock

- Double-bit security lock on the door and on the drawer

Insurance cover

Resistance grade VdS I

€ 20,000.00^{**} commercial

€ 65,000.00^{**} private



HPDI 1165

Series HPDI	Ext. dimensions H x W x D (in mm)	Interior dimensions H x W x D (in mm)	Weight (in kg)	Volume (in litres)	Capacity cash strong boxes ¹ /night strongboxes ²
HPDI 1165	1110 x 640 x 528	740 x 570 x 370	402	156	ca. 10 / ca. 25
HPDI 1265	1210 x 636 x 528	840 x 571 x 370	427	177	ca. 15 / ca. 35
HPDI 1365	1310 x 636 x 528	940 x 571 x 370	453	198	ca. 20 / ca. 50
HPDI 1565	1510 x 640 x 528	1140 x 570 x 370	504	240	ca. 30 / ca. 75

Measurements: ¹ round cash strongboxes ca. 48 x 85 mm ² night strongboxes ca. 195 x 111 x 61 mm

Deposit safes

Series HPDII

Euro resistance grade VdS class D-II according to EN 1143-2 (VdS 2528)

Construction

- Multi-walled doorkonstruktion
- All-round multi-walled corpus
- Padded interior, interior equipped with bulkhead plates
- Quadrilateral all-round fire insulation
- Fixture for floor anchorage

Lock

- Double-bit security lock (incl. 2 keys)

Insurance cover

Resistance grade VdS II

€ 50,000.00^{**} commercial

€ 100,000.00^{**} private

Basic configuration

- DIN right-hinged door
- Lacquered finish RAL 7035 light grey



HPDII

Series HPDII	Ext. dimensions H x W x D (in mm)	Interior dimensions H x W x D (in mm)	Weight (in kg)	Volume (in litres)	Capacity cassettes
HPDII 976	900 x 700 x 670	480 x 580 x 440	670	122	25
HPDII 1276	1200 x 700 x 670	780 x 580 x 440	830	199	50
HPDII 1576	1500 x 700 x 670	1080 x 580 x 440	1020	275	75

* The insurance sums specified are reference values only.

** The insurance sum will double if a VdS recognized burglar alarm system (BAS) is connected.

Deposit safes

Series HPDIV

Euro resistance grade VdS class D-IV according to EN 1143-2 (VdS 2528)

■ Construction

- Multi-walled door construction
- All-round multi-walled corpus
- Padded interior, interior equipped with bulkhead plates
- Quadrilateral all-round fire insulation
- Fixture for floor anchorage
- Prepared for installation of recognized burglar alarm system components ready for connection to a burglar alarm system (BAS)

■ Basic configuration

- DIN right-hinged door
- Lacquered finish RAL 7035 light grey

■ Lock

- Double-bit security lock (incl. 2 keys)

■ Insurance cover

Resistance grade VdS IV

€ 150,000.00^{*/**} commercial

€ 400,000.00^{*/**} private

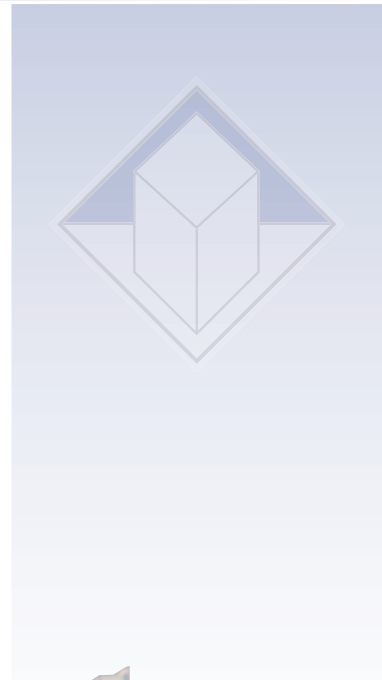

Deposit and drop-down safes

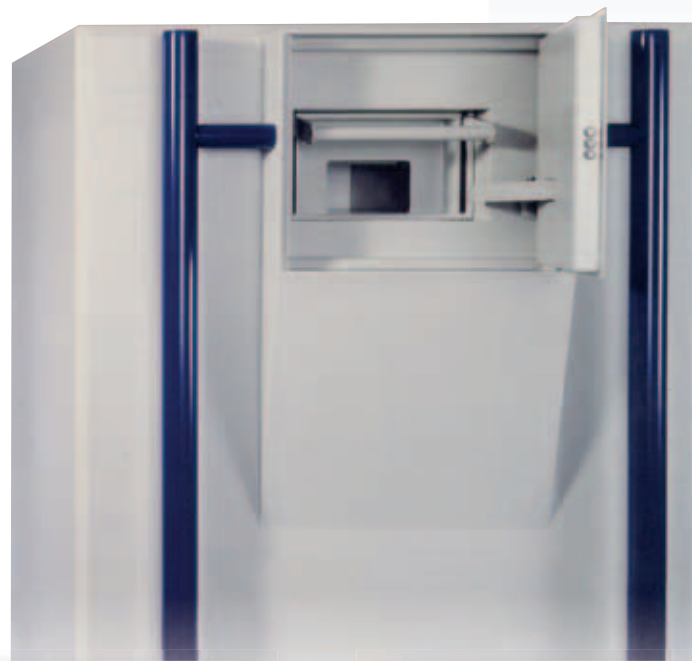

**Easy
cassette insert**



**Front view
of the free-standing unit**



**Back view
with door open**



HPDIV

Series HPDIV	Ext. dimensions H x W x D (in mm)	Interior dimensions H x W x D (in mm)	Weight (in kg)	Volume (in litres)	Capacity cassettes
HPDIV 1287	1200 x 870 x 760	600 x 690 x 480	1470	198	60
HPDIV 1587	1500 x 870 x 760	900 x 690 x 480	1770	298	90
HPDIV 1887	1850 x 870 x 760	1250 x 690 x 480	2050	414	120

Deposit safes

Series HTDTI

Euro resistance grade VdS class D-I according to EN 1143-2 (VdS 2528)

Construction

- All-round multi-walled corpus and door
- Door thickness 105 mm
- Drawer (488 mm high) on light running telescopic runners
- Protruding fittings at 60 mm

Basic configuration

- DIN right-hinged door
- Door opening angle of 180°
- Lacquered finish RAL 7035 light grey

Lock

- Double-bit security lock (incl. 2 keys)

Insurance cover

Resistance grade VdS I

€ 20,000.00*** commercial

€ 65,000.00*** private

New: available with deposit collection box



Series HTDTI	Ext. dimensions H x W x D (in mm)	Interior dimensions H x W x D (in mm)	Weight (in kg)	Volume (in litres)
HTDTI 1	1094 x 680 x 680	467 x 544 x 514	690	130
HTDTI 2	1294 x 680 x 680	667 x 544 x 514	780	187
HTDTI 3	1494 x 680 x 680	867 x 544 x 514	860	242

Deposit safes

Series HTDTII

Euro resistance grade VdS class D-II according to EN 1143-2 (VdS 2528)

Construction

- All-round multi-walled corpus and door
- Door thickness 114 mm
- Drawer (488 mm high) on light running telescopic runners
- Protruding fittings at 60 mm

Basic configuration

- DIN right-hinged door
- Door opening angle of 180°
- Lacquered finish RAL 7035 light grey

Lock

- Double-bit security lock (incl. 2 keys)

Insurance cover

Resistance grade VdS II

€ 50,000.00*** commercial

€ 100,000.00*** private

New: available with deposit collection box



Series HTDTII	Ext. dimensions H x W x D (in mm)	Interior dimensions H x W x D (in mm)	Weight (in kg)	Volume (in litres)
HTDTII 1	1094 x 680 x 680	471 x 564 x 515	ca. 740	136
HTDTII 2	1294 x 680 x 680	671 x 564 x 515	ca. 759	194
HTDTII 3	1494 x 680 x 680	871 x 564 x 515	ca. 905	259

* The insurance sums specified are reference values only.

** The insurance sum will double if a VdS recognized burglar alarm system (BAS) is connected.

Deposit safes

Series HTDTIII

Euro resistance grade VdS class D-III according to EN 1143-2 (VdS 2528)

■ Construction

- All-round multi-walled corpus and door
- Door thickness 137 mm
- Drawer (488 mm high) on light running telescopic runners
- Protruding fittings at 60 mm

■ Basic configuration

- DIN right-hinged door
- Lacquered finish RAL 7035 light grey

■ Lock

- Double-bit security lock (incl. 2 keys)

■ Insurance cover

Resistance grade VdS III

€ 100,000.00^{*/**} commercial

€ 200,000.00^{*/**} private

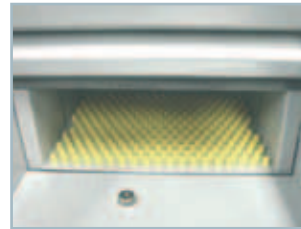

1. Fully pulled out drum draw shows a completely empty drawer.

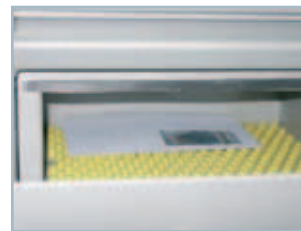

2. Inserted item (e.g. envelope with banknotes)



3. The inserted item can comprise several parts.



4. Upon closing the drawer, the inserted item will drop down into the secure area of the safe.

Side drawer also available as special equipment

New: available with deposit collection box



HTDTIII 1



Series HTDTI to HTDTIII

Special options: drawers in 9 variant forms

Right-sided, left-sided or reverse and either even or protruding at 200 mm or 500 mm.

Series HTDTIII	Ext. dimensions H x W x D (in mm)	Interior dimensions H x W x D (in mm)	Weight (in kg)	Volume (in litres)
HTDTIII 1	1094 x 680 x 680	455 x 528 x 475	ca. 860	114
HTDTIII 2	1294 x 680 x 680	655 x 528 x 475	ca. 960	164
HTDTIII 3	1494 x 680 x 680	855 x 528 x 475	ca. 1060	214

An insight into the company.



Hartmann Tresore

SCENE	ROLL	TAKE
DIRECTOR	CAMERAMAN	
SOUND	DATE	
PROD. CO.		

PICTURES SAY MORE THAN A 1000 WORDS!
WE ARE DELIGHTED TO BE ABLE TO GIVE YOU MORE OF A
DETAILED INSIGHT INTO OUR SAFE WORLD WITH OUR
COMPANY VIDEO.

VISIT OUR WEBSITE:
WWW.HARTMANN-TRESORE.DE





HARTMANN *Strongroom doors*

HARTMANN strongroom doors allow for the optimum protection of rooms or even whole parts of buildings.

This is a good alternative for companies, authorities or private people – particularly for those in new or renovated buildings, that not only want to lock away large valuable goods, but also larger volumes of valuables.

Strongroom doors esp. approved armoured strongroom doors offer a secure and comfortable solution for rooms where cabinets and safes no longer suffice and this, regardless of whether files and documents, extensive collections, weapons and ammunition, or narcotics etc. need to be kept secure.

■ Strongroom doors

- SERIES HPT according to security grade A
- SERIES HPTB according to security grade B
- SERIES HPTN VdS class N (0)
- SERIES HPTV 1-4 VdS class I
- SERIES HPTV 5-8 VdS class I + LFS 30 P
- SERIES HPTVB 5-8 VdS class I + LFS 30 P
- SERIES HPTII VdS class II
- SERIES HPTIII VdS class III
- SERIES HPTIII VdS class III + LFS 30 P

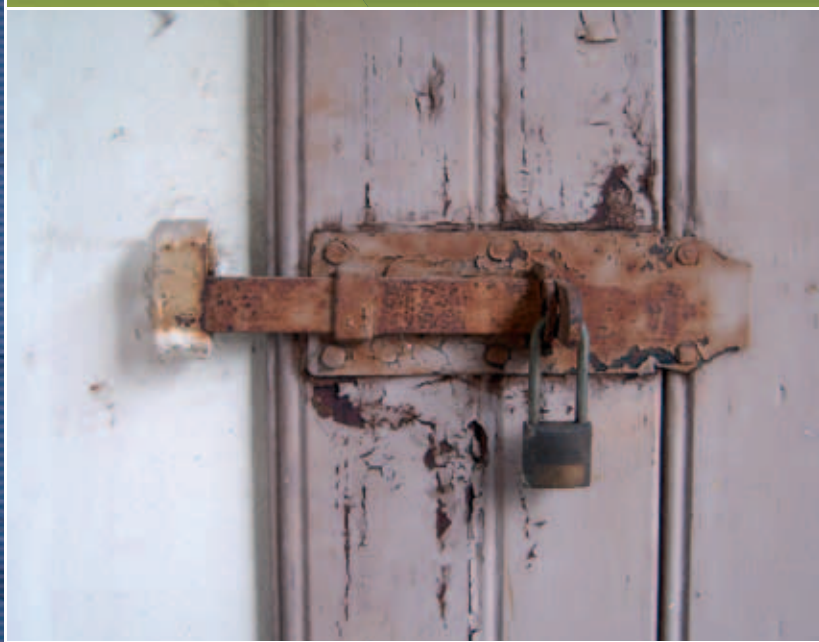

Strongroom doors

Series HPT

In line with **Security level B** according to VDMA 24992 05/95

■ Construction

- Double-walled door 75 mm
- Fire fold and fire-resistant insulation
- Standard frame depth 240 mm
- Bolt locking system

■ Lock

- Double-bit security lock (incl. 2 keys)

■ Basic configuration

- DIN right-hinged door
- Lacquered finish RAL 7035 light grey



Series HPT	Wall cutout dimensions h x w (in mm)	Ext. dimensions h x w (in mm)	Door passage dimensions h x w (in mm)	Weight (in kg)
HPT 1	1800 x 880	1835 x 930	1730 x 750	180
HPT 2	1800 x 1000	1835 x 1050	1730 x 870	195
HPT 3	2000 x 880	2035 x 930	1930 x 750	195
HPT 4	2000 x 1000	2035 x 1050	1930 x 870	215

Alternatively
also available
in security grade WK 5
(identical construction)

Strongroom doors

Series HPTB

In line with **Security level B** according to VDMA 24992 05/95

■ Construction

- Double-walled door 75 mm
- Fire fold and fire-resistant insulation
- Standard frame depth 240 mm
- Door filled with reinforced concrete
- Bolt locking system

■ Lock

- Double-bit security lock (incl. 2 keys)

■ Basic configuration

- DIN right-hinged door
- Lacquered finish RAL 7035 light grey

HPTB with special
concrete filling



Series HPTB	Wall cutout dimensions h x w (in mm)	Ext. dimensions h x w (in mm)	Door passage dimensions h x w (in mm)	Weight (in kg)
HPTB 1	1800 x 880	1835 x 930	1700 x 710	355
HPTB 2	1800 x 1000	1835 x 1050	1700 x 830	405
HPTB 3	2000 x 880	2035 x 930	1900 x 710	400
HPTB 4	2000 x 1000	2035 x 1050	1900 x 830	465

Strongroom doors

Series HPTN

Euro resistance grade VdS class N (0) according to EN 1143-1

■ Construction

- Four-walled door 125 mm
- Fire-resistant insulation according to DIN 4102
- Trilateral bolt locking system (hinged side secured with rear grip bolts)
- Bolt diameter \varnothing 35 mm
- Solid steel profile door frame
- Standard frame depth 240 mm
- Door opening angle of 180°
- Additional armoured: lock, locking system and bolt locking system area

■ Basic configuration

- DIN right-hinged door
- Lacquered finish RAL 7035 light grey

■ Lock

- Double-bit security lock (incl. 2 keys)

■ Insurance cover

Resistance grade VdS N (0)

€ 10,000.00* commercial

€ 40,000.00* private



HPTN 5/HPTN 6
With clamp frame
to set in concrete

Series HPTN	Wall cutout dimensions h x w (in mm)	Ext. dimensions h x w (in mm)	Door passage dimensions h x w (in mm)	Weight (in kg)
HPTN 1	1800 x 880	1835 x 930	1680 x 710	245
HPTN 2	1800 x 1000	1835 x 1050	1680 x 830	275
HPTN 3	2000 x 880	2035 x 930	1880 x 710	270
HPTN 4	2000 x 1000	2035 x 1050	1880 x 830	305
HPTN 5	2070 x 1000	2090 x 1040	1880 x 710	280
HPTN 6	2070 x 1120	2090 x 1160	1880 x 830	310

Strongroom doors

Series HPTV

Euro resistance grade VdS class I according to EN 1143-1

■ Construction

- Four-walled door 125 mm
- Fire fold and fire-resistant insulation
- Bolt locking system
- Bolt diameter \varnothing 35 mm
- Solid steel profile door frame
- Standard frame depth 240 mm

■ Basic configuration

- DIN right-hinged door
- Lacquered finish RAL 7035 light grey

■ Lock

- Double-bit security lock (incl. 2 keys)

■ Insurance cover

Resistance grade VdS I

€ 20,000.00* commercial

€ 65,000.00* private



Series HPTV	Wall cutout dimensions h x w (in mm)	Ext. dimensions h x w (in mm)	Door passage dimensions h x w (in mm)	Weight (in kg)
HPTV 1	1800 x 880	1835 x 930	1680 x 710	255
HPTV 2	1800 x 1000	1835 x 1050	1680 x 830	285
HPTV 3	2000 x 880	2035 x 930	1880 x 710	280
HPTV 4	2000 x 1000	2035 x 1050	1880 x 830	315

* The insurance sums specified are reference values only.

Strongroom doors

Series HPTV

Euro resistance grade VdS class I according to EN 1143-1 + LFS 30 P**

- | | |
|---|--|
| <ul style="list-style-type: none"> ■ Construction ■ Overall door thickness 105 mm ■ Multi-walled door and frame – heavy construction ■ Fire fold and fire-resistant insulation ■ Bolt locking system ■ Solid steel profile door frame ■ Standard frame depth 240 mm | <ul style="list-style-type: none"> ■ Basic configuration ■ DIN right-hinged door ■ Lacquered finish RAL 7035 light grey ■ Lock ■ Double-bit security lock (incl. 2 keys) ■ Insurance cover Resistance grade VdS I € 20,000.00* commercial € 65,000.00* private |
|---|--|

Special edition with wooden decor on door front
Special edition with wooden decor on door front

Series HPTV	Wall cutout dimensions h x w (in mm)	Ext. dimensions h x w (in mm)	Door passage dimensions h x w (in mm)	Weight (in kg)
HPTV 5	1800 x 880	1835 x 930	1700 x 710	225
HPTV 6	1800 x 1000	1835 x 1050	1700 x 830	245
HPTV 7	2000 x 880	2035 x 930	1900 x 710	240
HPTV 8	2000 x 1000	2035 x 1050	1900 x 830	260



image similar

Strongroom doors

Series HPTVB

Euro resistance grade VdS class I according to EN 1143-1+ LFS 30 P**

- | | |
|---|--|
| <ul style="list-style-type: none"> ■ Construction ■ Overall door thickness 105 mm ■ Multi-walled door and frame – heavy construction ■ Fire fold and fire-resistant insulation ■ Armoured concrete door filling ■ Bolt locking system ■ Solid steel profile door frame ■ Standard frame depth 240 mm | <ul style="list-style-type: none"> ■ Basic configuration ■ DIN right-hinged door ■ Lacquered finish RAL 7035 light grey ■ Lock ■ Double-bit security lock (incl. 2 keys) ■ Insurance cover Resistance grade VdS I € 20,000.00* commercial € 65,000.00* private |
|---|--|

Now available
in **LFS 30P****
tested and certified
according to EN 15659

HPTVB with special
concrete filling

Special edition with
wooden decor on
door front

Series HPTVB	Wall cutout dimensions h x w (in mm)	Ext. dimensions h x w (in mm)	Door passage dimensions h x w (in mm)	Weight (in kg)
HPTVB 5	1800 x 880	1835 x 930	1700 x 710	340
HPTVB 6	1800 x 1000	1835 x 1050	1700 x 830	375
HPTVB 7	2000 x 880	2035 x 930	1900 x 710	365
HPTVB 8	2000 x 1000	2035 x 1050	1900 x 830	405



image similar

* The insurance sums specified are reference values only.

**LFS 30P: only applies if the door is walled in/set in concrete professionally.

Strongroom doors

Series HPTII

Euro resistance grade VdS class II according to EN 1143-1

Construction

- Overall door thickness 152 mm
- Door leaf and door frame even on outside, floor frame max. 15 mm door sill
- Compact strong material in front of the locks incl. special reinforced filling
- Burglar-proof tested 50/80 RU
- Solid bolt locking system
- Standard frame depth 240 mm

Basic configuration

- DIN right-hinged door
- Lacquered finish RAL 7035 light grey

Lock

- Double-bit security lock (incl. 2 keys)

Insurance cover

Resistance grade VdS II

€ 50,000.00 ** commercial

€ 100,000.00 *** private



HPTII 2111

Series HPTII	Wall cutout dimensions h x w (in mm)	Ext. dimensions h x w (in mm)	Door passage dimensions h x w (in mm)	Weight (in kg)
HPTII 2111	2190 x 1200	2115 x 1100	1964 x 878	800

Strongroom doors

Series HPTIII

Euro resistance grade VdS class III according to EN 1143-1

Construction

- Overall door thickness 152 mm
- Door leaf and door frame even on outside, floor frame max. 15 mm door sill
- Compact strong material in front of the locks incl. special reinforced filling
- Burglar-proof tested 80/120 RU
- Solid bolt locking system
- Standard frame depth 240 mm

Basic configuration

- DIN right-hinged door
- Lacquered finish RAL 7035 light grey

Lock

- Double-bit security lock (incl. 2 keys)

Insurance cover

Resistance grade VdS III

€ 100,000.00 ** commercial

€ 200,000.00 *** private



Door with lattice on inside



HPTIII 2111

Series HPTIII	Wall cutout dimensions h x w (in mm)	Ext. dimensions h x w (in mm)	Door passage dimensions h x w (in mm)	Weight (in kg)
HPTIII 2111	2190 x 1200	2115 x 1100	1964 x 878	850

* The insurance sums specified are reference values only.

** The insurance sum will double if a VdS recognized burglar alarm system (BAS) is connected.

Strongroom doors

Series HPTIII

Security level Euro VdS class III 2450/EN 1143-1 + LFS 30 P***

- | | |
|--|--|
| <ul style="list-style-type: none"> ■ Construction ■ Multi-walled door ■ Multi-walled door frame ■ Overall door thickness 130 mm ■ Door frame depth suits 30-cm masonry ■ Standard frame depth 240 mm ■ Basic configuration ■ DIN right-hinged door ■ Lacquered finish RAL 7035 light grey | <ul style="list-style-type: none"> ■ Lock ■ Double-bit security VdS class II lock (incl. 2 keys) ■ Insurance cover Resistance grade VdS III € 100,000.00*** Commercial € 200,000.00*** Private |
|--|--|

Series HPTIII	Ext. dimensions h x w (in mm)	Door passage dimensions h x w (in mm)	Weight (in kg)
HPTIII 01	1700 x 900	1610 x 740	607
HPTIII 02	1800 x 900	1710 x 740	638
HPTIII 03	2000 x 1000	1910 x 840	751

**Now available
in LFS 30P**
tested and certified
according to EN 15659**



image similar

HPTIII 03



* The insurance sums specified are reference values only.

** The insurance sum will double if a VdS recognized burglar alarm system (BAS) is connected.

*** LFS 30P: only applies if the door is walled in/set in concrete professionally.



Components of a burglar alarm system (BAS)

Nearly all of our safes can be equipped with the complete burglar alarm system set or with individual components. The safes can therefore easily be connected to an existing alarm system or prepared for later planned connection to a burglar alarm system (BAS). By connecting your safe to a VdS recognized burglar alarm you will increase – as a general rule double – the respective insurance sum.

Construction of a burglar alarm system assembly set

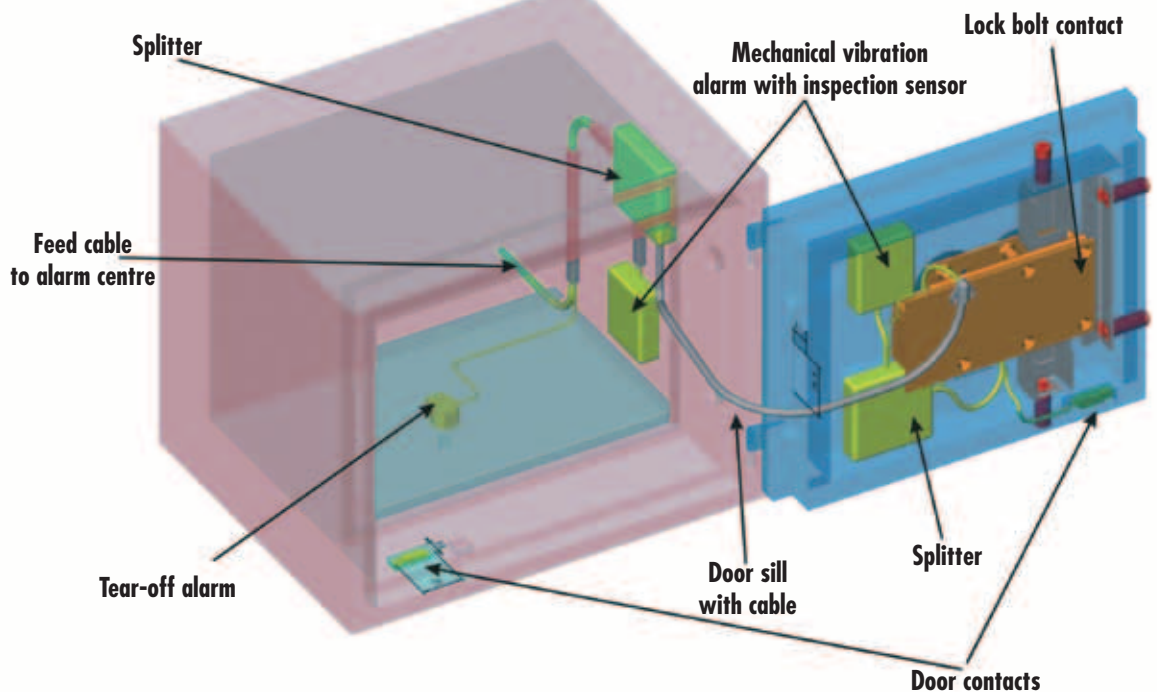

For more information, please send an e-mail to
info@hartmann-tresore.com

Double-bit locks

Selection with different fittings



Mechanical combination locks

Selection with different fittings



Electronic key-combination locks

Selection with different fittings





HARTMANN *Lock technology*

Our safes are fitted with a standard double-bit lock including at least two double-bit keys.

At this point, we would like to show you a selection of various locks, handles and fittings for your safe. Please note however, that not every safe can be combined and fitted with every lock and fitting.

After having assisted you in your search for the right safe, we would be more than happy to assist you in finding a suitable locking mechanism.



Tips and recommendations available from
our specialist consultants under:
info@hartmann-tresore.com



HARTMANN *Wooden safes*

Safes with real wooden casing. Behind the elegant real wooden casing of these cabinets you will find a solid steel cabinet with a double-walled door and a bolt locking system.

HARTMANN *Interior Design*

Drawers, compartment shelves and interior trim made of fine types of wood with an equally high-class interior lining. The interior of the Exclusive Line can be customised to suit your individual needs and desires.



HARTMANN *Airbrush safe*

Give your safe or rifle cabinet your own personal touch. Our airbrush artist knows his trade and will turn your safe into a real eye-catcher. Have your own personal design painted with your desired motif. Select a safe or a rifle cabinet from our extensive range that meets what you require and what you imagine with regards to size and security. Next, provide us with a template of your favourite motif.

Upon request we will offer you a fine wooden interior to nicely round off your individual choice.



HARTMANN *Art safes*

Safes could not get any more exclusive or customised. Witness the creation of smaller works of art with the help of the renowned artist Jean Tannous.

HARTMANN *High-gloss safes*

HARTMANN
TRESORE



HARTMANN *Exclusive Line*

Give your home or office a personal and elegant touch without having to compromise the latest security features and equipment.



Contact us to get your free *Exclusive Line* catalogue:
info@hartmann-tresore.com



HARTMANN *Bullet-proof glass display cases*

The bullet-proof glass display cases fitted with glass shelves are in use not only for private purposes, but also at museums, exhibitions etc. to securely present valuable exhibits.

HARTMANN *Bullet-proof rifle cabinets*

The bullet-proof glass display cases in a fine wooden look are also part of the HARTMANN TRESORE *Exclusive Line*.

There are large bullet-proof glass panes in the door and on the sides (depending on which model), as well as the right interior lighting. The setting will place your collections, rifles or other exhibits into a favourable light.

The high-class reinforced cabinets are certified according to stringent European standards: PREN 14450/2 and PREN 14450/1, respectively. This is comparable to the German Firearms Law and security grade B and security grade A, respectively. The actual resistance grade is, however, above that of steel cabinets categorised as grade B according to VDMA 24 992 (05/95).



HARTMANN *Solid wood rifle cabinets*

We offer exclusive cabinets and rifle cabinets that allow our customers to store their precious hunting weapons and collectors weapons.

HARTMANN solid wood rifle cabinets are certified according to EN 1143-1 Resistance grade 0 and are therefore suited for the storage of long and short firearms, and ammunition.

Our cabinets are crafted by traditional means as unique pieces. We offer sizes that verge off of the standard dimensions. These rifle cabinets can also be integrated into existing furniture or cupboards.

HARTMANN *bullet-proof glass safes*



*For further information about our bullet-proof glass safes:
please send an e-mail to: info@hartmann-tresore.com*



**Raffles tombolas
and presentations**

HARTMANN *Acrylic glass safes*

The acrylic safe is favoured at fairs, exhibitions and other events to present exclusive products, or carry out raffles and tombolas

HARTMANN TRANSPORTCASE FOR ACRYLIC GLASS SAFES



HARTMANN *Acceptance- and release safes*

HARTMANN *Narcotics safes*

According to § 15 of the Narcotics Law every person involved in the circulation of narcotics is obliged to store these separately and to secure them against unauthorised removal.

According to current security-related findings, sufficient safeguarding against unauthorised removal of such materials is only guaranteed if the container or facility for storing them meets the minimum stated requirements as stipulated in guidelines about measures to secure narcotics stocks (dated 01.01.2007).



HARTMANN BTM wall safe



HARTMANN *Coin safes*

HARTMANN *Hazardous substances cabinets*

The proper storage of hazardous substances has been regulated by the EN 14470-1 standard since April 2004. In terms of long-term investment in the area of hazardous substance storage, it should be checked that the cabinet(s) accord with this European standard.



HARTMANN *Mobile phone & cigarette safes*

HARTMANN
TRESORE



HARTMANN *Special safes*

In addition to the extensive standard range we also offer application-oriented solutions for security applications in the most diverse of commercial and industrial sectors.

Car dealerships, pharmacies, clinics, hotels, the gastronomy trade and branches from other sectors amongst others make up some of our satisfied customers.



For further information, send an e-mail to:
info@hartmann-tresore.com

Burglary security class	Insurance sum in Euro*		Security feature	Short description
	commercial	private		
Security level A according to VDMA 24992	2500,-	2,500.00	-	Single-walled steel body, double-walled door
Security level B according to VDMA 24992	from 300 kg up to 10,000.00	Wall safes (walled in according to instructions) and stand-alone safes from 200 kg up to 40,000,-	Limited burglary protection fire-proof according to DIN 4102	All-round fire fold, fire-resistant insulation in the walling; wall safe: double-walled door, single-walled body; furniture or business safe: completely double-walled
S1 according to EN 14450	2,500.00	5,000.00	200 SU	Single-walled corpus, double-walled door, all-round fire fold
S2 according to EN 14450	2,500.00	20,000.00	400 SU	Single/double-walled corpus, double-walled door
Euro VdS class N (0)	10,000.00	40,000.00	Tested burglar-proof according to guaranteed resistance unit 30/30	All cabinets with VdS-classes have a multi- walled door and body. The different resistance grades are reached by: the number, the material and the strength of the walls, as well as the fillings in the walls (e.g. special concrete filling with armoured matting).
Euro VdS class I	20,000.00	65,000.00	Tested burglar-proof according to guaranteed resistance unit RU 30/50	
Euro VdS class II	50,000.00	100,000.00	RU 50/80	
Euro VdS class III	100,000.00	200,000.00	RU 80/120	
Euro VdS class IV	150,000.00	400,000.00	RU 120/180	
Euro VdS class IV KB	250,000.00	To be agreed with the property insurer	RU 120/180	
Euro VdS class V	250,000.00		RU 180/170	
Euro VdS class V KB	375,000.00		RU 180/170	

The abbreviations in the table stand for:

SU = Security Unit (resistance of security cabinets against burglary)

RU = Resistant Unit (resistance of value containers against burglary)

VDMA = Verband Deutscher Maschinen- und Anlagebau (German Association for Mechanical Engineering and Installation)

VdS = VdS Schadenverhütung GmbH (formerly Verband der Schadensversicherer e.V.) (Vds Loss Prevention)

Security grades according to VDMA

Steel cabinets can be referred to as security grade A and B respectively, according to VDMA 24992, if the standards of the VDMA 24992 standard sheet (edition May 1995), as manufacturing specifications for these cabinets, are met. Market observation is inapplicable after withdrawal of the standard sheet by the issuing VDMA. Compliance with the regulations is however ratified by the nameplate on our safes (own conformance statement).

VdS standards

The basis for a VdS certification is the test and the acceptance procedure according to the European test specifications for safes (prEN). This test specification is based on a draft standard that has been developed by the CEN (European Committee for Standardization). This test guarantees quality control according to uniform standards and serves as a verification of security features, that is then used by insurers to determine the insurance cover sum. All VdS tested safes have the respective certificate in the form of a test badge on the inside of the door.

Fire security classes	Insurance sum in Euro*	Security feature	Short description
Quality grade LFS 30 P	To be agreed with the property insurer	30 minutes fire-proof for paper	Protection against fire, smoke and extinguishing water through special fillings and seals. The safes are available in different burglar security classes
Quality grade LFS 60 P		60 minutes fire-proof for paper	
Quality grade S 60 P		60 minutes fire-proof for paper	
Quality grade S 120 P		120 minutes fire-proof for paper	
Quality grade S 60 DIS		60 minutes fire-proof for data media	
Quality grade S 120 DIS		120 minutes fire-proof for data media	

Fire protection

Steel cabinets with security grade A offer more protection against fire than a normal cabinet or wardrobe. For safes with security grade B the heat generated in the safe is reduced by fire-resistant insulation according to DIN 4102 and an all-round fire fold. Given that the fire service can get to a fire site within an average of approximately 27 minutes, this protection is more than sufficient in many cases. VdS tested cabinets/safes offer increased fire protection. It is important to note however, that only safes that have been tested as fire-proof are actually safe from fire!

Safe protection from fire is tested according to EN 1047-1 and EN 1047-2, and EN 15659. Please read more about the test itself on page 30 and 31. Once a safe has passed the respective test, it is given its respective test badge according to RAL-RG 626/7.

* By connecting your safe to a VdS recognized burglar alarm system (BAS) you will increase – as a general rule double – the respective insurance sum.



Am Ziegenberg 3, 33106 Paderborn GERMANY		
Herstell datum Date de production Date of manufacture		
Normen / Regel Document Normatif Normative Document	EN 14450 ICIM 70R027	
Klasse Niveau Level	1	
Modell	Modèle	Model
Verrigting Serrure Lock ENV 1300 A		

Am Ziegenberg 3, 33106 Paderborn GERMANY		
Herstell datum Date de production Date of manufacture		
Normen / Regel Document Normatif Normative Document	EN 14450 ICIM 70R027	
Klasse Niveau Level	2	
Modell	Modèle	Model
Verrigting Serrure Lock ENV 1300 A		

Security grades - Insurance cover

When carrying out safety inspections for safes there is a difference between protection against a burglary and protection against fire. Independent test institutions carry out both tests according to precisely defined regulations. One institute is the VdS in Cologne; the other is the Institute for Material Testing at the University of Technology in Braunschweig (MPA). The safe is given a security grade according to its resistance. The insurance rating – and with it the sum of the insurance cover for the contents of the safe, is primarily based upon the security grade achieved in the test. The sums stated in our overview are non-binding reference values stated by property insurers. As a general rule, the insurance sum doubles if the safe is connected to a VdS certified alarm system (BAS).



Prüfzeichen	1000 1000	VdS Europäische Private Security Group
Widerstandgrad	EN 1143-1	
Anerkennungs-Nr.	10000 1001 VdS	
Fabrikations-Nr.	DEPLIN 00000	
Masse (kg)	367	
Maße (mm)	200 / 200	
VdS Schadenverhütung <small>Technische Regeln zur Europäischen EN 1143-1</small>		

Prüfzeichen	1000 1000	VdS Europäische Private Security Group
Widerstandgrad	EN 1143-1	
Anerkennungs-Nr.	10000 1001 VdS	
Fabrikations-Nr.	DEPLIN 00000	
Masse (kg)	367	
Maße (mm)	200 / 200	
VdS Schadenverhütung <small>Technische Regeln zur Europäischen EN 1143-1</small>		



If you have further questions about your insurance cover, please contact us under: info@hartmann-tresore.com

Fax No: +49 (0) 52 51-17 44 99

Order number:	Delivery possible:
Purchaser:	from _____ hrs to _____ hrs
Company:	Delivery not possible (absence, building works, etc.):
Department:	from _____ to _____
Name:	Is it necessary for us to carry the safe to the application site?
Postcode/City:	<input type="checkbox"/> yes <input type="checkbox"/> no (drop-off delivery possible)
Telephone:	If yes:
Fax:	<input type="checkbox"/> at ground level
Delivery address:	<input type="checkbox"/> up and over steps, see points 1 and 2
Company:	<input type="checkbox"/> via the lift, see point 3

Street:	General transport and delivery conditions: The delivery of the cabinets is at ground level and on a pallet. If so requested our qualified personnel can place the cabinet at the application site using the right and special equipment. Please ask your designated consultant about the costs of placement on site.
Postcode/City:	
Telephone (daytime): _____ (evenings): _____	
Fax (daytime): _____ (evenings): _____	

1. Route of transport outside of the building:

- 1.1 Ground floor no steps? yes no
- 1.2 If there are steps how many? _____ steps
- 1.3 for point 1.2: possible protruding edges? yes no
- 1.4 What material covers the steps? _____
- 1.5 Can a lorry bridge a gap to the steps with a rear tail-lift? yes no
- 1.6 Parking spaces available? yes no
- 1.7 Surface route of transport? _____
- 1.8 Is there a loading ramp available? yes no
- 1.9 Is a forklift available? yes no

2. Route of transport within the building:

- 2.1 Ground floor no steps? yes no
- 2.2 If there are steps how many? _____ steps
- 2.3 Possible protruding edges? _____ edges
- 2.4 What material covers the steps? _____
- 2.5 Application site in the cellar? yes no
- 2.6 Application is on floor _____?
- 2.7 Type of stairs (see below and cross what is appropriate)
- 2.8 Stair construction, e.g. wooden or steel stairs etc. _____
- 2.9 To point 2.7 and 2.8 stand-alone? yes no
walled in? yes no

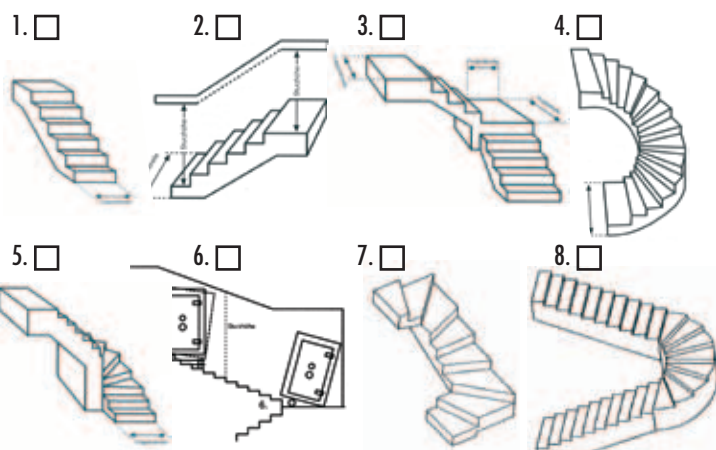

- 1. Straight stairs without underbeam
- 2. Straight stairs with underbeam
- 3. Stairs 90° angled with landing
- 4. Spiral stairs curved 180°
- 5. Stairs with 90° turn
- 6. Stairs 180° turn and with landing
- 7. Stairs 2 x 90° turns without landing
- 8. Stairs 1 x 180° turn without landing

3. Lift transport

- 3.1 Can the safe be transported in the available lift? yes no
- 3.2 Is a transportation using the stairs in addition to the lift necessary? yes no
- 3.3 Is the lift capacity sufficient for transporting the cabinet? yes no
- 3.4 Size of the lift:
Door height and width: _____

4. Anchorage

- 4.1 Would you like the safe to be anchored? yes no

Place, date _____ Signature _____

Request for further information

Fax No: +49 (0) 52 51-17 44 99

Please send me additional information on the following:

- Hotel safes**
- Hazardous substances cabinets**
- Narcotics safes**
- Special safes for car dealers & car rental services**
- Rifle cabinets**
- Bullet-proof glass display cases**
- Bullet-proof safes**
- High-gloss safes**
- Art safes**
- Airbrush safes**

Other:

Name/Company:

Contact person/Surname, First name:

Telephone:

Fax:

Street, No.:

Postcode, City:

E-mail:

STAMP

■ PRODUCTS

Shop safes
Private safes
Fire-proof safes
Wall safes
Rifle cabinets
Data safes
Filing cabinets
Furniture safes
Hotel safes
Key safes
Strongroom doors
Airbrush safes
Bank safes
Patient safes
Second-hand safes

■ PERFORMANCE

Every security grades
Every size
Every colour
Customized products

■ SERVICES

On-site consulting
Disposal of old safes
Removals
Immediate help if burgled
Investigation of damages
Rental safes
Leasing & financing



Authorities | public administration

Akademie der Polizei Baden-Württemberg · Amtsgericht Hamburg · Amtsgericht Köln · Auswärtiges Amt Berlin · Belgisches Generalkonsulat · Beschaffungssamt des Bundesministerium des Inneren · Botschaft der Republik Kroatien · Botschaft der Republik Singapur · Botschaft der Volksrepublik China · Bundesanstalt für Arbeit · Bundesgrenzschutz NRW · Bundesministerium für Wirtschaft · Drogenambulanzen Hamburg GmbH · Freie & Hansestadt Hamburg · Hamburger Senat · HH Immobilien Management für Polizei & Feuerwehr GmbH · Iranische Botschaft · Japanische Botschaft · Japanisches Generalkonsulat Hamburg · Kreispolizeibehörde Ennepe-Ruhr-Kreis, Schwelm · Landeskriminalamt NRW · Landespolizeidirektion Karlsruhe · Landkreis Kassel Schulen und Bauwesen · Niedersächsisches Forstamt · Polnische Botschaft · Polizei Oberhausen · Polizeipräsidium Bonn · Regierungspräsidium Darmstadt · Russische Botschaft · Staatsanwaltschaft Bielefeld · Stadtbauamt Ettlingen · Stadt Bad Kissingen · Stadt Bergisch Gladbach · Stadt Bielefeld · Stadt Bonn · Stadt Düsseldorf · Stadt Hamm · Stadt Karlsruhe · Stadt Köln · Stadt Minden · Stadt Mühlheim an der Ruhr · Stadt Paderborn · Stadt Verden · Stadtverwaltung Frankenthal · Wasser- und Schifffahrtsamt Duisburg

Banks | Insurance companies

Agenur für Deutsche Vermögensberatung · Allianz Versicherungs AG · Alte Leipziger · AXA AG · Continental Versicherung · Bundesverband Deutscher Banken · Deutsche Bank AG · Deutsche Bundesbank Frankfurt · DEVK Versicherung · DKV AG · Germanischer Lloyd · Gothaer Versicherung · Hamburg Mannheimer Versicherung · Hiscox AG · KVB Krankenversicherung der Bundesbahnbeamten · Norisbank AG · Provinzial Versicherung · Raiffeisenbanken · Sparkassen · Vereinte Versicherung AG · Volksbank · Württembergische Versicherung · Zürich Group Invest Europe GmbH

Industry

3m Deutschland · adidas-Salomon AG · Benteler Stahl GmbH · Bentley Motors Ltd. · Bertelsmann GmbH · Brandt Zwieback-Schokoladen GmbH & Co. KG · Daimler Chrysler AG · Douglas Holding AG · Ford Werke AG · Gebr. Gauselmann GmbH · Glaskoch B. Koch jr. GmbH & Co. KG (Leonardo) · Haribo GmbH & Co. KG · Henkel KGaA · KIA Motors Deutschland GmbH · KiK-Textilien & Non-Food GmbH · Melitta Kaffee GmbH · Peugeot Deutschland · Pfälzische Mühlenwerke GmbH · Porsche Zentrum · Alfred Kärcher Vertriebs-GmbH · Schwarzkopf Holding · Schwarz Pharma Deutschland GmbH · Siemens AG · Siemens Gebäudetechnik · Siemens Nixdorf · Tommy Hilfiger · ThyssenKrupp AG · Volkswagen AG · Warsteiner Brauerei Haus Cramer · Wincor Nixdorf International GmbH · micas AG · RÜTTGERS Chemicals GmbH

Energy | suppliers

Aral Tankstellen · BP Tankstellen · Esso Tankstellen · RWE DEA AG · Kernkraftwerk Stade · Shell Tankstellen · Stadtwerke Paderborn · VEBA Öl AG · JET Tankstellen

Trade companies

Artus Friseurfachhandel · BIBA + pariscop Daub GmbH · C&C Handelshof · Edeka · EuroFlorist Deutschland GmbH · Mango Deutschland GmbH · Poco Einrichtungsmärkte GmbH

Service companies

BVG Berlin (Berliner Verkehrsgemeinschaft Berlin) · DeTe Immobilien · Deutsche Bahn AG · Deutsche Klassenlotterie · GAG Immobilien AG · HRS Hotel-Reservation-Service · IFN Finance GmbH · Österreichische Bundesbahnen · TÜV Nord

Leisure facilities

24 Hour Fitness · Löwen Play GmbH & Co. KG · Merkur-Spiel GmbH · Sea Life Dresden · Sunpoint Systemzentrale · Timex Spielstätten GmbH · Video Buster

Car rental services

Enterprise rent-a-car · Europcar Autovermietung · Sixt GmbH & Co.

Tourism administration | Airlines

AERO Lloyd Flugservice GmbH · Airbus Deutschland GmbH · airtours International GmbH · Air Anatolia · Air Berlin GmbH · EL-AL Israel Airlines Ltd. · LTU GmbH · Lufthansa · Travel Ex Deutschland GmbH · TRS Touristik Service GmbH · TUI AG · TUI Leisure Travel GmbH

Telecommunication companies

Bharath Telecommunication GmbH & Co. KG · Deutsche Telekom AG · Vodafone · O₂

Hotels

Accor Hotellerie Deutschland GmbH · Acora Hotels · ArabellaSheration Hotels · Best Western Hotels · Crown Plaza Hotel · Hilton Hotels International · Holiday Inn Hotels · Lindner Hotels AG · Maritim Hotels · Marriott Hotels · Radisson SAS Hotels · Steigenberger Hotels · Swisshötel

Catering companies

Burger King GmbH · Cocoon Club GmbH & Co. KG · Eurest Deutschland GmbH · KHH Süllberg Betriebsgesellschaft mbH & Co. KG · McDonalds · Pizza Hut Yum! International Ltd. & Co. KG · Residenz Heinz Winkler · Stockheim Gastronomie · Subway EAT fresh · World of Pizza

Welfare

AWO Sozialpsychiatrisches Zentrum · Deutsche Krankenhausesellschaft · Ev. Krankenhaus Duisburg · Ev. Waldkran-kenhaus Bad Godesberg · Helios Klinikum Erfurt · Klinikum Bad Neuenahr GmbH & Co. KG · Klinikum der Universität Köln · Klinikum Erfurt GmbH · Klinikum Karlsruhe · Klinikum Krefeld · Marcus-Klinik GmbH & Co. KG, Bad Driburg · Urologische

Klinik, München · Seniorenresidenz Rüpcke GmbH · St. Johanneshospital Dortmund · St. Josef Hospital, Oberhausen · St. Josefs Krankenhaus, Salzkotten · Uniklinikum Düsseldorf · Universitätsklinikum Erlangen · Universitätsklinikum Ulm

Religious institutes

Diakonisches Werk Mobiflex, Dortmund · Ev. Bruderschaft Kecharismai, Dettlingen · Ev. Kirchengemeinschaft Hochstadt · Ev. Lutherische Gemeinschaft Brockhagen · Kath. Kirchen-gemeinde St. Maria, Düsseldorf · Kath. Pfarramt Zum heiligen Kreuz, Düsseldorf · Kirchengemeinde St. Petri, Wuppertal · Lutherische Kirchengemeinde, Lage · Sekretariat der Äthiopisch-Orthodoxen Kirchen in Deutschland

Universities | Institutes

Bernhard-Nocht-Institut für Tropenmedizin · Institut für Ur- und Frühgeschichte · Universität Bonn · Universität der Bundeswehr München · Universität Frankfurt · Universität Gießen · Universität Hamburg · Universität Hannover · Universität Köln · Universität Münster · Universität Osnabrück · Universität Rostock · Universität Siegen · Universität Stuttgart

Organisations | Clubs

BONBAG GmbH · Deutscher Segler-Verband e.V. · FC St. Pauli Vermarktungs GmbH & Co. KG · FIFA Fußball-Weltmeisterschaft 2006 · Jägervereinigungen · Kassenärztliche Vereinigung · Kassenzahnärztliche Vereinigung Hamburg · Landesjagdverbände · Landessportbund Niedersachsen · SV Tangendorf von 1925 e.V. · Verein für Bewegungsspiele Lübeck von 1919 e.V. · Verein für Jugendhilfe e.V. Pinneberg

Film | Theater companies

B&T Filmproduktion Berlin · Babelsberg Film GmbH · Bavaria Film GmbH · Deutsche Oper am Rhein · Kieft & Kieft Filmtheater GmbH (Cinestar & Cinemaxx) · Novafilm Fernsehproduktion GmbH · Network Movie GmbH & Co. KG · MTM Filmproduktion · Musical MAMMA MIA · Stream Films AG · Studio Hamburg Produktionen · Theater in der Speicherstadt · UFA-Theater GmbH

Media

ARD · Rundfunkanstalt · RTL Television · SFB Hauptstadtstudio · WDR · ZDF · Norddeich TV · Sony Pictures Film und Fernseh Produktions GmbH

Shipping companies

A-ROSA Flussschiff GmbH · Barkassen-Centrale Überseebrücke Günter Ehlers · Carneval Cruise Line · Fairplay Schleppdampfschiffs-Reederei Richard Borchard GmbH · Neptun Reparaturwerft GmbH · NSB Niederelbe Schifffahrtsgesellschaft mbH & Co. KG · Seetours · Star Cruises Newbuilding · Teekay Marine Services GmbH & Co · Thien & Heyenga GmbH (Bereederung u. Befrachtung) · Schleppreederei Kotug Hamburg GmbH · VMF Shipping GmbH

An extract from our list of references

Besides renowned companies from the most diverse of branches and sectors as well as small and medium-sized companies, authorities, institutes and private customers equally trust in the quality and service provided by HARTMANN TRESORE.



HARTMANN TRESORE AG

-HEAD OFFICE-

Trading Division

Pamplonastrasse 2

33106 Paderborn

Telefon +49 (0) 52 51 - 17 44 -0

Fax +49 (0) 52 51 - 17 44 -99

HARTMANN TRESORE HAMBURG

Vorsetzen 41

20459 Hamburg

Telefon +49 (0) 40 - 36 90 54 -30

Fax +49 (0) 40 - 36 90 54 -59

HARTMANN TRESORE BERLIN

Kurfürstendamm 63

10707 Berlin

Telefon +49 (0) 30 - 88 70 87 -70

Fax +49 (0) 30 - 88 70 87 -89

HARTMANN TRESORE DUSSELDORF

Graf-Adolf-Strasse 70

40210 Düsseldorf

Telefon +49 (0) 2 11 - 17 93 73 -49

Fax +49 (0) 2 11 - 17 93 73 -50

HARTMANN TRESORE COLOGNE

Hohenstaufenring 48-54

50674 Köln

Telefon +49 (0) 2 21 - 8 20 18 -20

Fax +49 (0) 2 21 - 8 20 18 -28

www.hartmann-tresore.com

info@hartmann-tresore.com



HARTMANN

TRESORE AG